

Love of life begins with "Rcom"

REPTILE60

Ver. 2

DIGITAL REPTILE INCUBATOR USER'S MANUAL

REPTILE MAX 60

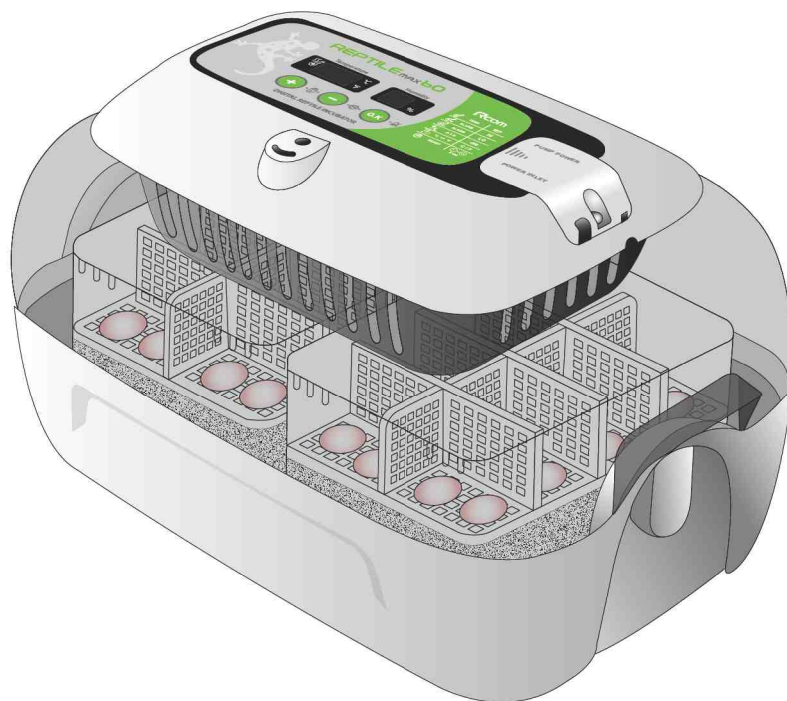

Rcom



How to use Rcom Reptile MAX 60

1. Introduction	
(1) Rcom Reptile 60 Introduction	3 ~ 6
(2) Safety precautions	
(3) Identification of Parts and Composition	
(4) Name & Function of Operation Parts	
2. Before use	
(1) What is an Incubation Room?	7 ~ 8
(2) How to Assemble	
3. Incubation	
(1) Incubation Installation / Incubation Start	9 ~ 10
(2) Dew Condensation / Water Makeup / Candling	
(3) Incubation Termination	
4. Function Settings	
(1) Return to Factory Setting	11 ~ 14
(2) Temperature Setting	
(3) Abnormal high, Low temperature alarm setting method	
(4) Abnormal high, Low humidity alarm setting method	
(5) Daily Temperature Range(D.T.G) setting method	
(6) How to change Centigrade & Fahrenheit	
5. How to Clean	
(1) Disassembling and Cleaning the Incubator	15
6. Understanding	
(1) Recommended temperature and humidity table by reptile during incubation	16
7. Product Information	
(1) Troubleshooting	18 ~ 19
(2) Specification	

Introduction
Before use
Incubation
Function Settings
How to Clean
Understanding
Product Information

⚠ The result of Hatching and Brooding can be changed by a large numbers of factors. Autoelex Co., Ltd. & our distributors will not take any responsibility for 'Loss of eggs or pet/animal lives' under any circumstances such as 'Hatching/Brooding failures', 'User's carelessness', 'Personal (un-certificated) conversion / alteration', 'Arbitrary using out of the machine's purpose', 'Electric power failure', or 'Malfunctioning'. Please be sure that the machine works without any problem before placing Eggs or Pets(Animals). Also, we strongly recommend you to read the User's Manual carefully to minimize of any failure.

Mark Explanation



Caution : Caution mark against a fault that can cause damage, trouble, or failure of incubation.



Prohibited.



It is necessary to keep.



Do not disassemble.



Remove the power cord from outlet.



Do not touch.



Ground Connection for preventing electric shock.



Tip : References or useful suggestions in using Rcom product



CAUTION Warning of actions which may be dangerous or cause damage to the incubator.

Rcom Reptile 60

First of all, we would like to express our deep appreciation for all the customers who purchased Rcom Reptile Incubator. Rcom Reptile Incubator was designed to be used easily and conveniently by the newest digital control method for controlling optimal incubation environment automatically, however, in order to get the best incubation result, at first, it is very important for users to have some incubation knowledge and right machine operation method. Therefore, before using incubator, be sure to read instruction manual. Rcom Reptile Incubator provides the best incubation environment, however, it is necessary for users to observe and adjust each environment necessary for incubation including egg kind, temperature and humidity management by incubation date, surrounding conditions of incubator, and this product was made it possible to make the best setting for all the environments necessary for incubation.

Features of Rcom Reptile 60

[Main Function]

- * Incubation exclusively for practical reptile with a streamline concept of egg shape.
- * Automatic temperature control and setting function.
- * Indicate several kinds of information with FND that visibility is excellent.
- * Artificial intelligence automatically controlling its adjustment period according to the exterior environment of incubator.
- * Reliability improvement by the 3rd generation temperature and humidity sensor of Swiss Sensirion Company.
- * Clean and transparent large view window.
- * Electronic control unit one touch removal method for providing cleaning convenience.
- * Variable air control lever that can adjust incubator air content.
- * Container tray of chamber organ that prevents egg from being dried and that individual management is possible.
- * Daily temperature range setting function(D.T.G)



Daily temperature range function means as follows : It is a function artificially making the highest time zone of temperature by sun at the natural condition, and it is a function that can raise the incubation success rate of reptile by the optimal incubation environment by raising temperature at the fixed time zone.

[Easy Function]

- * Centigrade and Fahrenheit changing function.
- * Alarm(buzzer) and indication function informing abnormal temperature and humidity(high and low temperature/high and low humidity) for rapid exterior temperature change.
- * Incubation Data memory function due to power failure and power failure alarm notification display function.
- * Formation structure that the water drops(Drew Condensation) being formed on the view window don't flow out to the outside of incubator.
- * Rotary Heater Support that that can adjust tension of heater conveniently.
- * A sanitary instrument mechanism inhibiting double heat insulated structure and bacteria reproduction by combination of Bottom and container tray through an innovative technology that can minimize parasitic bacteria by disusing interior materials.

Electrical hazards

CAUTION Be careful the details below when you use.

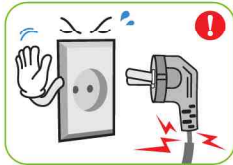

Do not use a damaged power cord or loose outlet.
▶ Risk of electric shock or fire.



Do not pull the cord when taking out the power cord, and keep wet hands away from connecting plug.
▶ Risk of electric shock or fire.

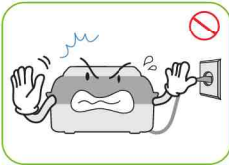

Never pull the plug out of the outlet during the incubation period.
▶ Incubation will be interrupted.



Do not twist or crush electric cord.
▶ Risk of electric shock or fire.

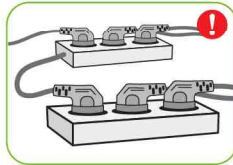

Do not insert multiple connecting plugs in an outlet.
▶ Risk of fire or electrical overload.

Setting Cautions

CAUTION Be careful the details below when you use.



Do not install in dusty or dirty environment.
▶ Risk of damage or fire within the incubator.

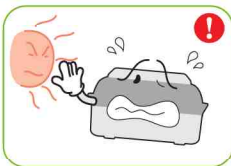

Do not install under the direct sunlight.
▶ Risk of fire or interference with the incubation process.

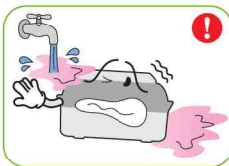

Do not install in moist or humid environment.
▶ Risk of fire or electric shock.



Do not install in excessively cold or hot conditions, cigarette smoke, etc.
▶ Risk of interference with the incubation process.

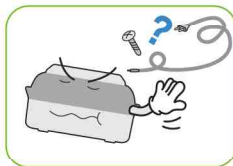

Do not use any other non-standard parts except those provided.
▶ Risk of damage or hatching failure.



Do not cover the ventilating opening.
▶ Inner temperature can rise, interrupting incubation.

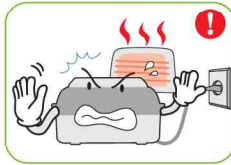

Install away from heat sources.
▶ Risk of damage to the incubator case and interference with the incubation process.

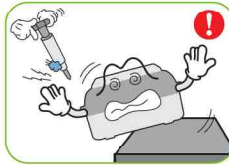

Ensure that the incubator is installed on a stable surface away from edges.
▶ Risk of damage to incubator and eggs and user from accidental knocks or drops.



Do not turn the incubator upside down.
▶ Water will pour out of the incubator, and view window can be dropped or damaged.

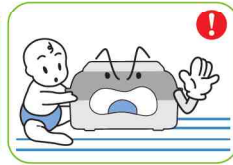

Children should be supervised to ensure that they do not play with the appliance.

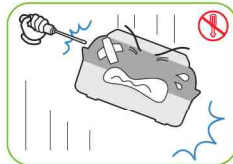

Do not disassemble or modify the incubator in any way.
▶ Risk if electric shock or fire.

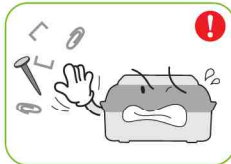

Please ensure that no small objects get into the holes on the incubator.
▶ Risk of electric shock or fire.

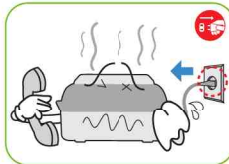

If the incubator sounds strange or emits smoke contact your service center.
▶ Risk of electric shock or fire.



Clean the incubator thoroughly before storing.

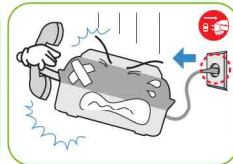

If the incubator requires repair disconnect from the power supply and please contact to your service center.

Cleaning Cautions

CAUTION Be sure to disconnect the electric cord from the outlet before cleaning.



Do not spray cleanser directly on the incubator surface.

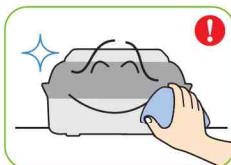

Clean the incubator by a soft cloth with a neutral detergent.



Brush away dust on the plug with a dry cloth.

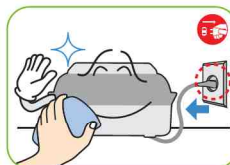

Do not use chemicals like wax, benzene, alcohol, thinner, aromatic, or lubricant, etc.

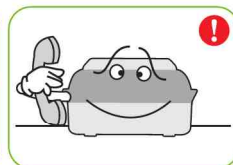

For special cleaning of inner part per year, contact to the service center.
▶ If you don't clean the inside of incubator for a long time, dust can cause some trouble or a fire.

Identification of Parts

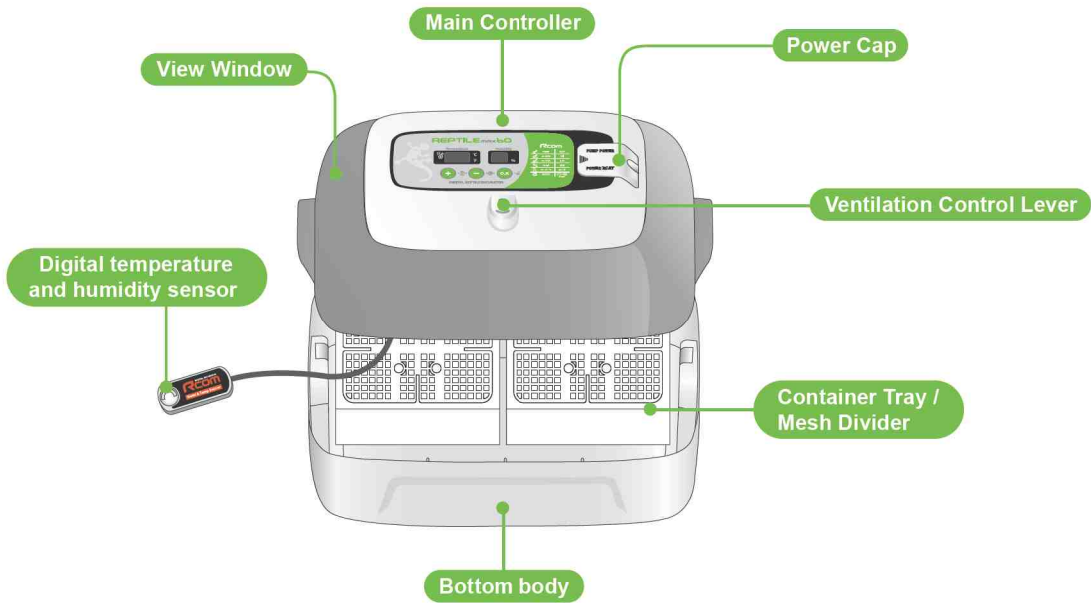

Basic Components

Serial NO. was indicated on the left of main controller. Please make it not be contaminated.(Example:RCM0000000)



Rated voltage and product serial No. are marked inside of power cover. Be sure to check this before connecting power.



Name & Function of Operation Parts

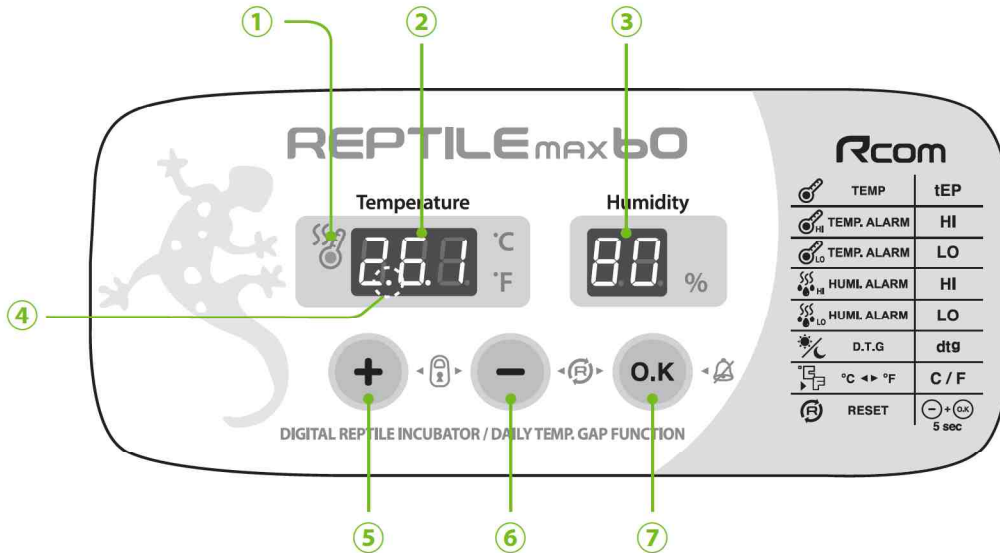

• Name & Function of Operation Parts

- ① **Heater Operation Lamp**
: Light on when working
- ② **Temp. Display**
: Current Temperature Display
- ③ **Humidity Display**
: Current Humidity Display
- ④ **Power Failure Alarm Function**
: Light on when power failure (Cancel Button : OK)
- ⑤ **Up Button**
: Setting Temp. UP
- ⑥ **Down Button**
: Setting Temp. DOWN
- ⑦ **Menu Selecting Button**
: Setting Value check

TIP Reptile MAX 60 doesn't have automatic humidification function.

	Setting Mode: Press two buttons at the same time to go to Setting Mode.
	Select Menu / Quick Movement / Cancellation / Setting value check during incubation
	Value +
	Value - / Factory Initialization

• **Function Key** Press buttons at the same time to cancel password.

Function	Temp.	Abnormal high temp. alarm	Abnormal low temp. alarm	Abnormal high humi. alarm	Abnormal low humi. alarm	Daily temp. range set	Centigrade / Fahrenheit
Display	tEP	HI →	LO →	HI →	LO →	dtg →	°C / °F
Default Setting	26.1°C	0°C	0°C	95%	70%	ON	°C

What is an Incubation Room?

Incubation room? It means the place where the incubator is installed and operated, and as it has much effect on incubation rate according to the environment of incubation room, it is good to install incubator at the place where there is little noise and vibration in the vicinity and the temperature range isn't severe in the temperature of 22~25°C (71.6~77°F). In particular, as there are many cases that the temperature falls rapidly in the nighttime differently from the daytime, it is necessary to check certainly, and during daytime, incubator must not be exposed directly to the sunlight.

How to Assemble

When installing reptile incubator, in case that the temperature of incubation room is higher than its set temperature, the temperature control of incubator inside may not be done normally. The set temperature of incubation room should be around 4°C (7.2°F) lower than incubator set temperature.

- ▶ Unpack incubator and separate each part to do assembly and check if there is some omission or damage (Don't throw away product box to utilize it for safe product keeping.)
- ▶ Register Serial NO. on the left of main controller. Free warranty period shall be extended to 2 years. Please see Rcom homepage for details. [see 17 page.]

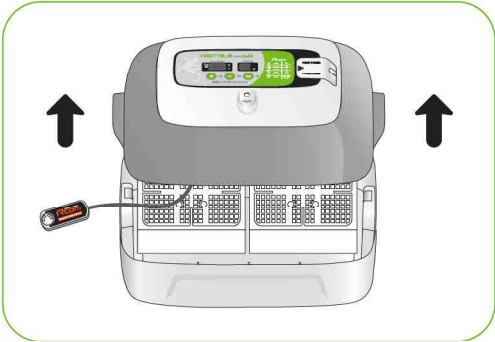

- ▶ Score one or two times with a knife along length furrow of one mesh divider and breadth furrow of two mesh dividers by seeing figure. Don't cut two sheets of mesh dividers.

⚠ During using knife, be careful not to get some damage on the hands or other body part. Specially, the guidance of elders is necessary for children.

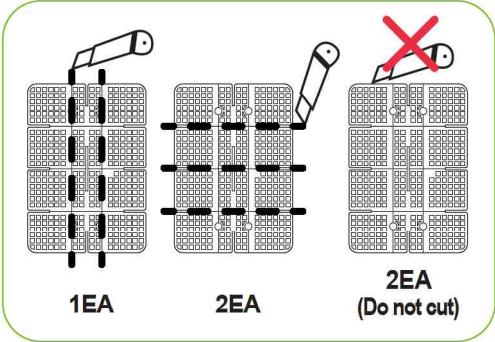

- ▶ Bend it along a knife line to divide Divider.
- ▶ As seen in the figure, spread uncut mesh divider on the bottom and stand long divider in the mid to make compartment as much width as wanted by inserting short divider between them.

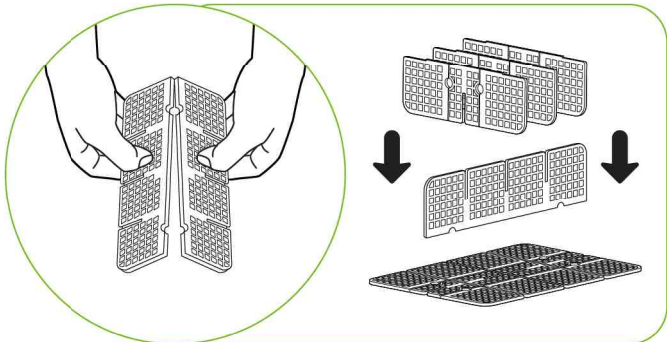

REPTILE MAX 60 Incubator doesn't have any automatic humidity control function. It is recommendable to incubate by testing if its required humidity is kept after mixing reptile vermi and water into container tray rather than incubating immediately and raising temperature up to the incubating temperature.

- ▶ Mix water 700~800cc with a bag of reptile vermi per one container tray and pour into 40~45mm height.

Tip It is possible to purchase the vermiculite for reptile incubation separately.

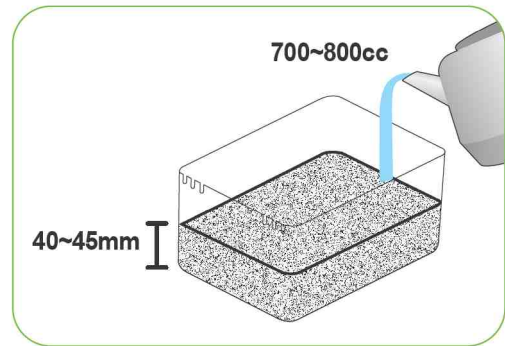

- ▶ Incubation humidity depends on the quantity of the water mixed with reptile vermi, surrounding temperature and humidity, and incubator set temperature. Please check the moisture state of reptile vermin every two weeks.

! In case that the reptile vermi was completely dried, it may be in very dry state by absorbing the surrounding humidity of incubator inside and egg. It is good to start after understanding the required environment for each reptile kind and making previous test if incubation environment is proper to minimize incubation failure.

! It is good for reptile vermi not to be reused after incubation. Incubation rate falls notably because of Bacteria contamination. [It is possible to purchase at the place you purchased.]

Tip When reptile laid eggs, they should be moved to the incubator as the first direction when laying eggs was. It is convenient to making a marking on the egg in order for them not to be changed.

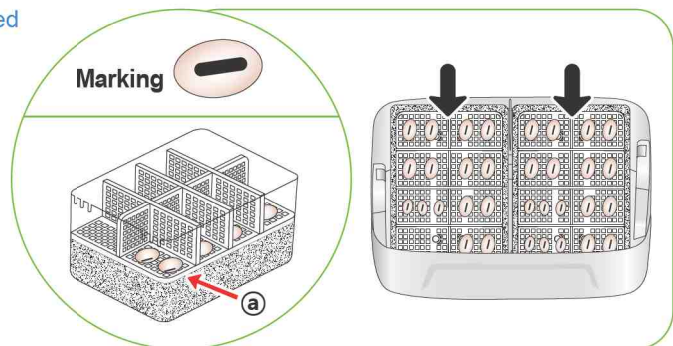

- ▶ Put assembled divider on the reptile vermi and put eggs on the compartment.

- ▶ Insert container tray carefully in the bottom body.

- ▶ It isn't necessary to spread the divider of figure (a).

- ▶ Put sensor line into container tray furrow and be sure to close all covers of tray and sight glass.

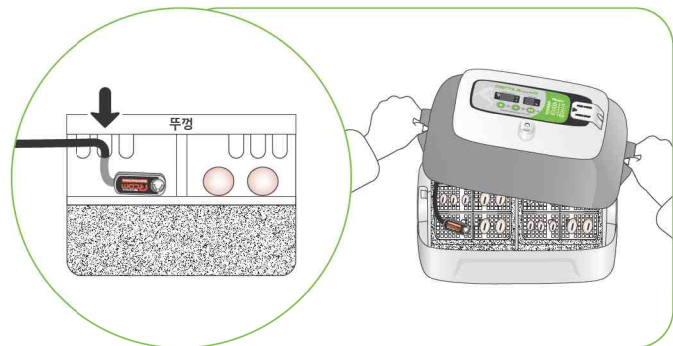

! For the compartment inserting sensor, please insert sensor only in order to protect egg damage.

! In case that the sight glass isn't closed completely, temperature doesn't go up. Be careful.

Preparation for Incubation / How to Start Incubation

! Before inserting eggs, please start incubation after checking if all functions work without any problem by operating incubator sufficiently.

▶ Open power cap to plug-in and close power cap again to lock bolt.

! When locking bolt, be careful for cord not to be trapped in the power cap.

! Open power cap to find the sticker indicating a rated voltage on the **(a)** that was attached to the main body. It is necessary to plug-in after checking if power supply voltage to use is proper.

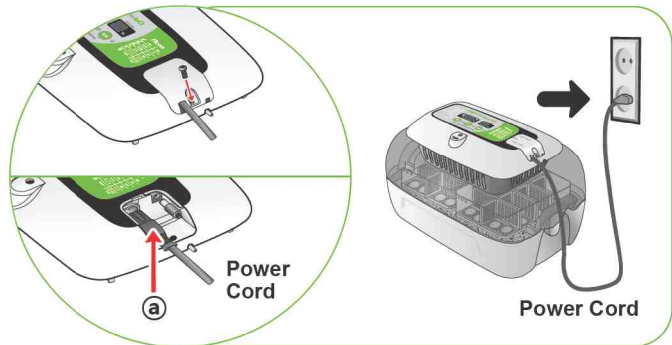

▶ In case of connecting power cord of incubator, incubation starts at the existing set temperature and humidity. [temperature of initial shipment 26.1°C (78.98°F)]

Tip There can be some odor the first time you use incubator, which is normal.

▶ The first time you connect power, FND light will blink and pump will work for about 2sec. Then, incubator version will be indicated on FND for about 1 sec.

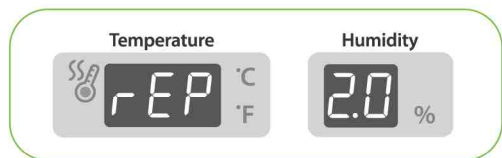

▶ After version indication, buzzer sounds for about 15sec. At the same time, present temp. & humidity displayed and power failure alarm indication **(a)** is blinking.

▶ Press **(O.K)** button to remove buzzer and alarm indication. (Buzzer will be removed automatically after 15sec.)

※ Notice of Power Failure : If power is turned off and then on again because of power failure or by mistake, first dot will blink.

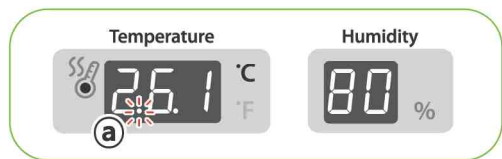

Tip Quick Start : If you just connect power, it automatically starts incubation with factory setting. [Factory setting : Temperature 26.1°C (78.98°F)]

▶ It indicates present temperature and humidity of incubator, and it goes up to the set temperature value in 1~2 hours. (No humidity control function)

※ The artificial intelligence system memorizes and classifies ambient conditions for keeping optimum temperature, and temperature can move up slowly at the first stage.

Dew Condensation

- ▶ This is a naturally occurring phenomenon when there is a significant difference in temperature between inside and outside of the incubator during incubation period. If this occurs, water may form in inside bottom of the incubator (bottom part).

 Do not place any goods near the incubator.

Water Makeup

- ▶ Refill water into each container tray once a month.
- ▶ Pour warm water of 300cc on the edge of each container tray carefully in order for water not to be touched to egg and sensor.

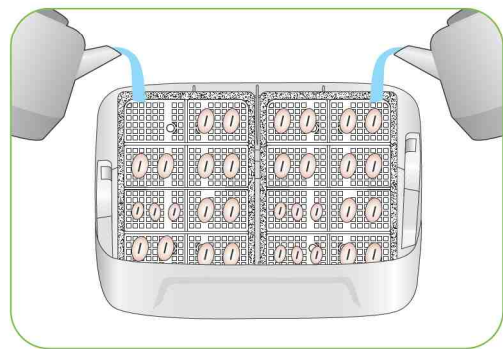

Candling

- ▶ Please candle with an egg candler once a week. Open the cover of sight glass and container tray and flash a light with an egg candler to candle egg. Remove infertile eggs or incubation-stopped eggs.

 Be careful for eggs not to be lifted and for shocks not to be given.

 Egg candler for exclusive use - See Rcom homepage.

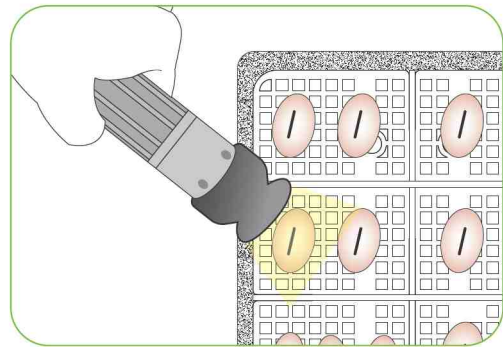

Incubation Termination

- ▶ There is no specified ON or OFF button on the incubator. Just take off the power cord after hatching.
- ▶ It is not necessary to do Incubator Initialization with REPTILE MAX 60 incubator after hatching. Just connect power again when you want to start incubation again.

Return to Factory Setting

- ▶ This function is for return incubator to factory setting.
- ▶ Unplug power cord. Replug during **(-)** button is pressed. Then, "rSt AL" will indicated in display, and incubator return to factory setting. (Default setting)

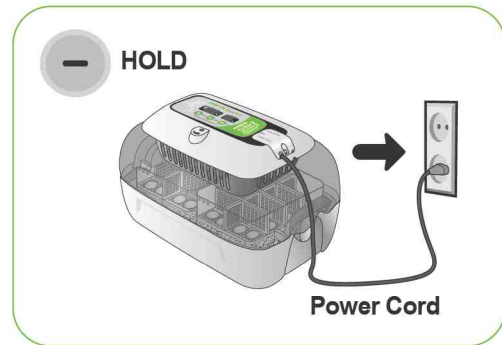

Factory Setting Display

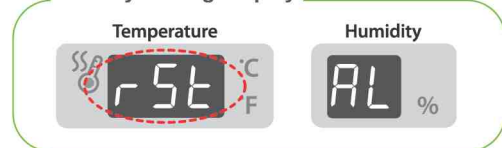

Temperature Setting

- ▶ Press **(+)** and **(-)** button at the same time then "tEP" will be indicated for about 0.5sec. and then temp display will blink.
- ▶ When temperature indicator flickers, press **(+)** button or **(-)** button each to increase or decrease temperature to 0.1°C level. [Default setting : 26.1°C (78.98°F)]
- ▶ In case of pressing **(o.k)** button after changing into wanted value, temperature value is saved and "HI" is displayed (abnormal high temperature alarm) as a next step at temperature display window for 0.5 seconds and its set value flickers.

Step 1

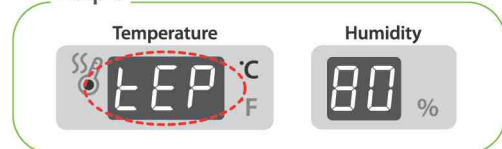

Step 2

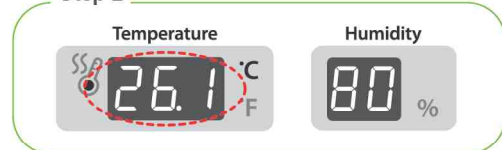

※ In case of not wanting to change setting, press **(o.k)** button to go to the next step.

Tip When releasing from the factory, temperature was corrected to be optimized according to international standard. If necessary, recorection is possible, however, it isn't desirable for users to correct it directly. In case that correction is necessary, please contact Rcom homepage (www.Rcom.co.kr→data center → Instruction manual catogoty) or place where you purchased to inquire about it. As low price thermometer and hygrometer easy to purchase in the open market have much deviation of estimate value, it is desirable to use corrected thermometer and hygrometer for exclusive use. [thermometer and hygrometer for exclusive use – See Rcom homepage]

Abnormal high temp. alarm setting method



Abnormal high temperature alarm function?

It is a function informing users of that the temperature of incubator inside raised because of abnormal temperature, and in case that the surrounding temperature of incubation room is higher than the set temperature of incubator, it is continuously alternated ringing buzzer and displaying set temperature range (example: 3°C) on the temperature window. After that, even though temperature is recovered to the normal state, it keeps ringing buzzer and flickering repeatedly until it is cancelled by pressing OK button.

- ▶ In case of pressing **(OK)** button one time at the temperature set method stage, "HI" is displayed at the temperature window for 0.5 seconds and the alarm set value flickers.
- ▶ When the alarm set value flickers, press **(+)** or **(-)** button each to increase or decrease its set value to 1°C level. [Default setting : OFF = 0°C (0°F)]
- ▶ In case of pressing **(OK)** button after changing into wanted value, alarm set value is saved and "LO" is displayed (abnormal low temperature alarm) as a next step at temperature display window for 0.5 seconds and its set value flickers.



※ It displays that it was 3°C (5.4°F) higher than incubation set value during incubation.

Step 3

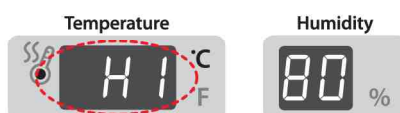

Step 4



Abnormal low temp. alarm setting method

- ▶ In case of pressing **(OK)** button one time at the abnormal high temperature set method stage, "LO" is displayed at the temperature window for 0.5 seconds and the alarm set value flickers.
- ▶ When the alarm set value flickers, press **(+)** or **(-)** button each to increase or decrease its set value to 1°C level. [Default setting : OFF = 0°C (0°F)]
- ▶ In case of pressing **(OK)** button after changing into wanted value, alarm set value is saved and "HI" is displayed (abnormal high humidity alarm) as a next step at humidity display window for 0.5 seconds and its set value flickers.



In case of abnormal low temperature: In case of abnormal low temperature, "LO" is displayed at humidity display window and it is the same as at the abnormal high temperature.



※ It displays that it was 2°C (3.6°F) lower than incubation set value during incubation.

Step 5

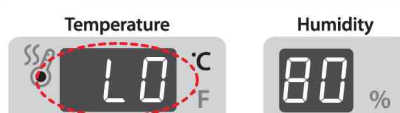

Step 6

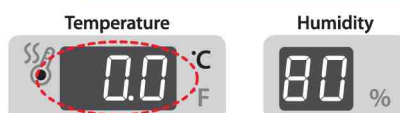

REPTILE MAX 60 Incubator doesn't have any automatic humidity control function. But, it has an alarm function informing it to the users in case of getting out of necessary humidity range during incubation. In case that alarm set humidity range is too sensitive, frequent alarm may ring, however, in case of cancelling this function, just OFF alarm function. (See step 7~10) ※ Abnormal humidity alarm rings for 15 seconds only in the initial occurrence.

Abnormal high humi. alarm setting method

Tip Abnormal high humidity alarm function?
It is a function informing users of that the humidity of incubator inside raised because of abnormal humidity, and in case that it is higher than the set humidity of incubator, it is continuously alternated ringing buzzer and displaying set humidity range(example: 5%) on the humidity window. After that, even though temperature is recovered to the normal state, it keeps ringing buzzer and flickering repeatedly until it is cancelled by pressing OK button.

- ▶ In case of pressing (o.k) button one time at the abnormal low temperature set method stage, "HI" is displayed at the humidity window for 0.5 seconds and the alarm set value flickers.
- ▶ When the alarm set value flickers, press (+) or (-) button each to increase or decrease its set value to 1% level. [Default setting : RH 95%]
- ▶ In case of pressing (o.k) button after changing into wanted value, alarm set value is saved and "LO" is displayed (abnormal low humidity alarm) as a next step at humidity display window for 0.5 seconds and its set value flickers.

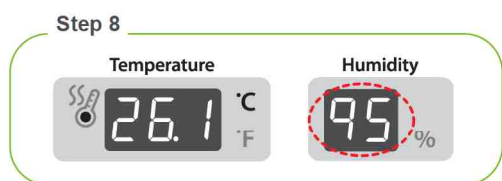
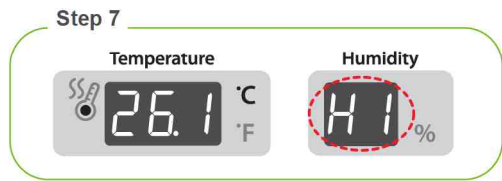

※ It displays that its inside humidity was temporarily higher than abnormal high humidity alarm set value(RH 95%) during incubation.

Abnormal low humi. alarm setting method

- ▶ In case of pressing (o.k) button one time at the abnormal high humidity set method stage, "LO" is displayed at the humidity window for 0.5 seconds and the alarm set value flickers.
- ▶ When the alarm set value flickers, press (+) or (-) button each to increase or decrease its set value to 1% level. [Default setting : RH 70%]
- ▶ In case of pressing (o.k) button after changing into wanted value, alarm set value is saved and "dtg" is displayed (daily temperature range) as a next step at humidity display window for 0.5 seconds and its set value flickers.

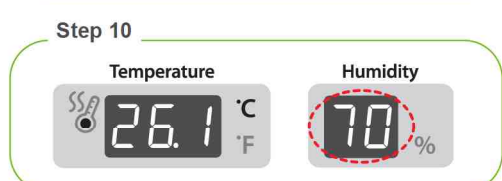
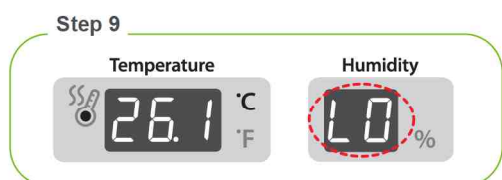

Tip In case of abnormal low humidity: In case of abnormal low humidity, "LO" is displayed at temperature display window and it is the same as at the abnormal high humidity.



※ It displays that its inside humidity was temporarily lower than abnormal low humidity alarm set value(RH 70%) during incubation.

Daily Temp. Range(D.T.G) setting method

- ▶ Daily temperature range (D.T.G)?
It is a function artificially making the highest time zone of temperature by sun at the natural condition, and it is a function that can raise the incubation success rate of reptile by the optimal incubation environment by raising temperature at the fixed time zone.
- ▶ In case of pressing (OK) button one time at the abnormal low humidity set method stage, "dtg" is displayed at the temperature window and its set value flickers.
- ▶ When the alarm set value flickers, press (+) or (-) button each to change to "ON" ↔ "OFF" [Default setting : ON]
- ▶ In case of pressing (OK) button after changing into wanted value, changed set value is saved and "C . F" (Centigrade /Fahrenheit)" is displayed as a next step at temperature window for 0.5 seconds and LED of "C" flickers.
- ▶ In case D.T.G was already set, for 3 hours of 24 hours, the inside temperature of incubator goes up 1.5°C more than set value, and "dtg" is displayed with temperature alternately at the temperature display window.

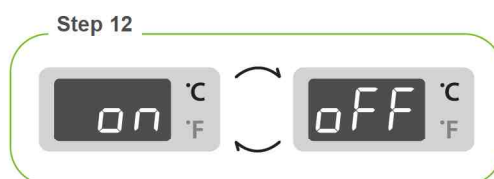
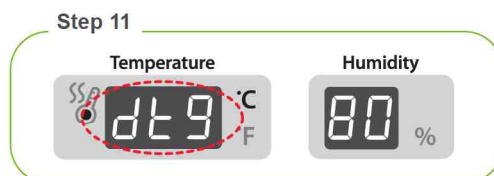

How to change Cels. & Fahr.

- ▶ Whenever pressing (+) or (-) button, LED flickers into "°C" ↔ "°F" alternately. [Default setting : °C]
- ▶ After selecting wanted display, press (OK) button to be set. [Default setting : °C]

Tip $^{\circ}\text{C} = 5/9 (^{\circ}\text{F} - 32)$

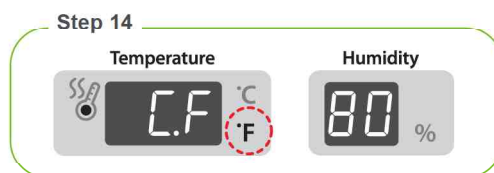
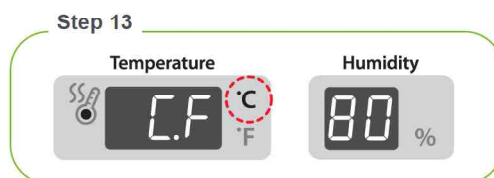

Disassembling and Cleaning the Incubator

⚠ Be sure to take off power cord before cleaning the incubator.

▶ In case of immediately turning off the incubator progressing incubation with a high humidity and leaving it at the state that the cover was closed, as the humidity remaining in the inside evaporates and is attached to the electric device, it may be a cause of breakdown. Be sure to remove inside humidity after getting off transparent window to use machine the most safely.

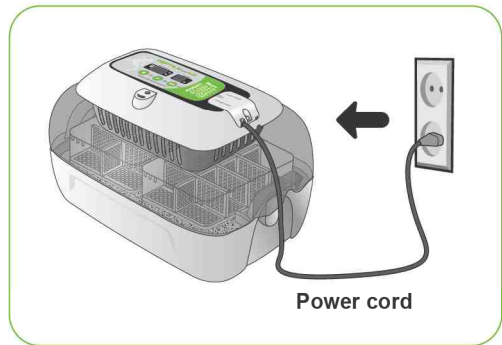

- ▶ Remove main controller from view window.
- ▶ Sensor unit is connected to the connector to be changed easily in case of breakdown.

⚠ Never wash sensor unit with water. It may be a cause of breakdown, and it may decrease the life span of sensor.

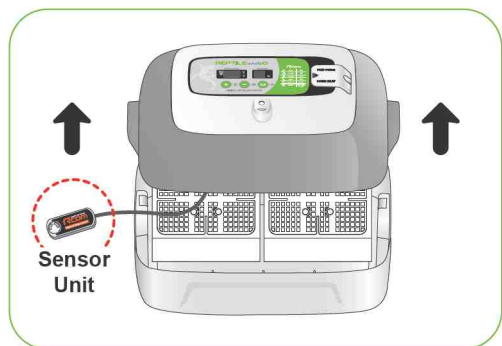

- ▶ Wash the outside of main controller, transparent window and sensor cleanly with a soft cloth.
- ▶ Wash container tray, mesh divider, main body(bottom) cleanly with warm water and dry them at cool place.

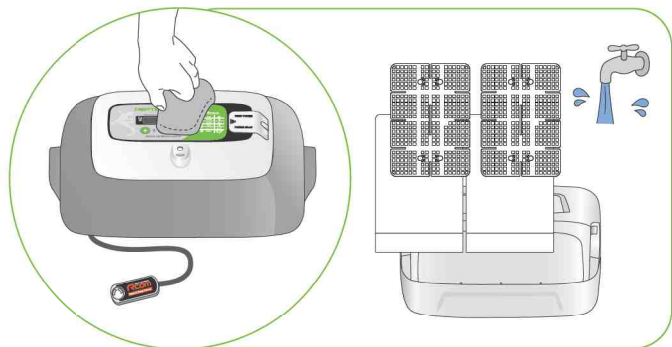

▶ Assemble again in the opposite order separated to keep it.

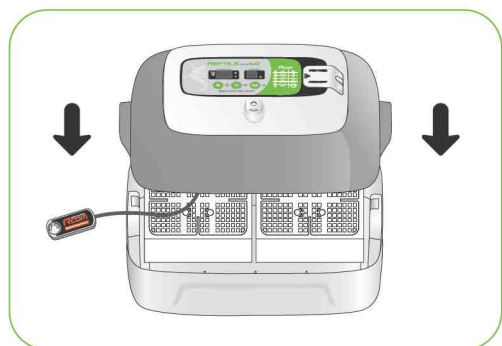

6. Understanding

(1) Recommended temp. and humi. table by reptile during incubation

REPTILE60

Recommended temp. and humi. table by reptile during incubation

Reptile Grouping	SPECIES	INCUBATION PERIOD	TEMPERATURE	HUMIDITY	DAILY TEMPERATURE GAP
Chameleon	Veiled Chameleon	145-180 days	26.1°C / 79°F	80%	
Turtle	Box Turtles	70-80 days	27.8°C / 82°F	85%	
	Sea Turtle	58-62 days	29.4°C / 85°F	95%	
	Painted Terrapin Turtle	72-80 days	29.4°C / 85°F	95%	
	Snapping Turtle	60-85 days	29.4°C / 85°F	95%	
Tortoise	Desert Tortoise	85-90 days	30.6°C / 87°F	80%	
	European Tortoise	56-84 days	30.6°C / 87°F	75%	
	Mediterranean Tortoise	56-70 days	30.6°C / 87°F	75%	
Snake	North American King Snake	60-65 days	28.3°C / 83°F	90%	
	North American Milk Snake	60-65 days	28.3°C / 83°F	90%	
	North American Rat Snake	60-65 days	28.3°C / 83°F	90%	
	Corn Snake	55-60 days	29.4°C / 85°F	85%	
	King Snake	60-65 days	28.3°C / 83°F	90%	
	Amazon Tree Boa	40-50 days	31.1°C / 88°F	95%	
	Python	60-65 days	32.2°C / 90°F	90%	
Iguana	Green Iguana	73-80 days	29.4°C / 85°F	85%	
Lizard	Bearded Dragon Lizard	60-70 days	28.9°C / 84°F	85%	
	Uromastyx	55-65 days	33.9°C / 93°F	92%	1.5°F/3hour
	Chinese water dragon	60-75 days	29.4°C / 85°F	85%	
	Tegu	60-70 days	28.3°C / 83°F	90%	
	Lizard	50-60 days	30.6°C / 87°F	87%	
	Day Gecko	50-65 days	27.8°C / 82°F	75%	
	Gecko	50-55 days	29.4°C / 85°F	88-90%	1.5°F/3hour
Alligator	Alligator (Mississippiensis)	63-84 days	31.7°C / 89°F	95%	
	Crocodile (Crocodylus porosus)	89-95 days	30.6°C / 87°F	95%	
Other	Unknown Reptile	50-90 days	30.6°C / 87°F	85%	

※ The recommended environmental conditions as the reptiles may differ slightly.

Troubleshooting

For more detailed self-diagnosis, see Rcom homepage "SELF DIAGNOSIS" category.

All our Rcom digital products of Autoelex Co., Ltd. are made by precision systems under strict quality control. But occasionally some defective products are found on the way of their distribution. If any problem occurs, then please contact Autoelex service center or distributors in your country. We will do our best to solve the problems, if any, for you. This product is designed in modular mode, so for its repair, if any, a qualified person can replace the part concerned with ease.

* Complaint Department : 82-55-337-2560

* E-mail Receipt : Rcom@Rcom.co.kr

Troubles	Expected Causes (Possibility)	Countermeasures
No signs of power to the incubator.	<ul style="list-style-type: none"> ▶ Check if power cord was connected well. ▶ Check power failure. ▶ Check if plug is defective. 	<ul style="list-style-type: none"> ▶ Try to plug-in again. ▶ Check other electric and electronic product nearby. ▶ Check after moving to other socket.
When temperature is too high / When temperature is too low	<ul style="list-style-type: none"> ▶ Check set temperature. ▶ Check if FAN for air circulation doesn't rotate. ▶ Try to make factory initialization. [See 11 page] 	<ul style="list-style-type: none"> ▶ Adjust set temperature to wanted temperature. ▶ Unplug from socket and separate main body to clean FAN area for air circulation with a brush or writing brush.
When humidity is too high / when humidity is too low	<ul style="list-style-type: none"> ▶ Try to make factory initialization. [See 11 page] <p><When low></p> <ul style="list-style-type: none"> ▶ Check if reptile vermin(vermiculite) contains water. ▶ Check if sight window closed well. <p><When high></p> <ul style="list-style-type: none"> ▶ Check surrounding environment. ▶ Check if tray inside or main body(bottom) contains water. 	<ul style="list-style-type: none"> ▶ Refill water sufficiently. <p><when low></p> <ul style="list-style-type: none"> ▶ Please add water to reptile vermi (vermiculite) for eggs not to be wet. [See 10 page] ▶ Check if foreign substance was inserted and close it again. <p><when high></p> <ul style="list-style-type: none"> ▶ Adjust environment of incubation room. [See 7 page]
The machine makes some noise. It is normal that the machine emits some sounds because it uses air circulation fan for working.	<ul style="list-style-type: none"> ▶ Check if there is some other object on the incubator. ▶ Check if there is some vibration on the floor or it was installed on the desk. ▶ Check if some foreign substance was attached to FAN area after incubation. 	<ul style="list-style-type: none"> ▶ Remove all the objects put on the incubator. ▶ Move incubator to the safe place to install. ▶ Unplug from socket and separate main body to clean FAN area for air circulation with a brush or writing brush.
Water leaks from the machine. * In case of keeping at high humidity, there may be some dew.	<ul style="list-style-type: none"> ▶ As reptile incubator operates at high humidity, there is some dew on the sight window. It isn't a breakdown but natural phenomenon. 	<ul style="list-style-type: none"> ▶ Please install within the condition of incubation room.

 **Before inserting eggs, please start incubation after checking if all functions work without any problem by operating incubator sufficiently.**

Specification

1-1 Name : Rcom Reptile MAX 60

1-2 Model : MX-R60

Power	AC 100~120[V], 50/60[Hz] / AC 220~240[V], 50/60[Hz]		
Temp. Control Range	20 ~ 42[°C] / 68 ~ 107.6[°F]	Outside Environment Temp.	Optimal range : 22 ~ 25[°C] / 71.6 ~ 77[°F]
			(Low) 20[°C] / 68[°F] (High) 26[°C] / 78.8[°F]
Power Consumption	Average 15[W] Max. 48[W]		
Capacity	60[eggs] (Different from the species of egg)		
Product Weight	2.8[Kg](N.W) / 4.3[Kg](G.W)		
Product Size	(W).70×(L)231×(H)209[mm]		
FUSE Standard	250[V] 2.0[A] (Ø5*20[mm])		

Register your product Serial No. on our website for free 2 years guarantee.
Refer to website for how to register. (Free 1 years guarantee in case not registerd.)

※ Product Registration Procedures

If you are a new member of Rcom, you need to log in our website at www.Rcom.co.kr

1. Click "SIGN UP" on top of the right corner.
2. Fill out the information on the blanks.

If you already registered your information on the Rcom website, please log in to www.Rcom.co.kr.

1. Click "Login" on top of the right corner.
2. Select "Customer" and click "Register Products".
3. Fill out the information on the blanks.

You will need below information to register on our website.

1. Your name
2. Your (home/company) address & Email address, country
3. Your product(model) name & Serial number
4. Date of purchase & Name of purchased shop you bought from

Rcom Incubator Series

It is possible to check additional information at Rcom homepage (www.R-com.co.kr).



Rcom PRO MINI
Package (PX-03S)



Rcom KINGSURO
MAX 20 (MX-SURO)



Rcom REPTILE
MAX 90 (MX-R90)

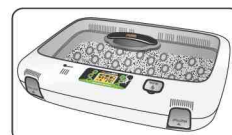

Rcom REPTILE
PRO 230 (PX-R230)



Rcom DIGILOG2
(PX-V2)

Product Warranty

Product Name : _____

Date of sales : year month date

Name of customer : Telephone Number : Mailing address : _____

Place of purchase : Telephone Number : Mailing address : _____



Consumer compensation for the damage

- When requesting repair, as you should show this warranty that purchase date was indicated to get satisfactory service, we request you to keep it well.

Consumer damage type	Compensation content	
	within warranty period	after warranty period expired
In case of the naturally occurred breakdown in performance and function during normal use	Free repair	Credit repair
Breakdown in performance and function due to consumer's intention or fault	Credit repair	
<ul style="list-style-type: none"> ■ In case of the breakdown caused by Natural disaster (fire, damage from sea wind, gas, earthquake, damage from storm, etc.) ■ In case of exchanging the consumable parts that are worn normally during use ■ In case of the breakdown caused by power problem and connector defect ■ In case of the breakdown because the person who isn't a repair technician of main office or agency repaired or recomposed ■ In case that the breakdown was made by the external cause, not other product's own defect ■ In case of the breakdown caused by different use of rated voltage ■ In case of the breakdown caused by the use of the consumables and optional products undesignated by this company ■ In case of the breakdown or damage caused by the falling during movement ■ Breakdown occurred by no cleaning / Breakdown occurred by not using distilled water / Breakdown occurred when incubator was used for development(brooding) / Breakdown occurred by wrong machine operation / Breakdown occurred by using with the method that wasn't suggested in the instructio / the case that consumer fault is obvious. 		

⚠ The result of Hatching and Brooding can be changed by a large numbers of factors. Autoelex Co., Ltd. & our distributors will not take any responsibility for 'Loss of eggs or pet/animal lives' under any circumstances such as 'Hatching/Brooding failures', 'User's carelessness', 'Personal (un-certificated) conversion / alteration', 'Arbitrary using out of the machine's purpose', 'Electric power failure', or 'Malfunctioning'. Please be sure that the machine works without any problem before placing Eggs or Pets(Animals). Also, we strongly recommend you to read the User's Manual carefully to minimize of any failure.

* Customer Center : +82. 55. 337. 2560 * E-mail contact : Rcom@Rcom.co.kr

Please see detailed consumer damage compensation regulation at "Customer Center" of Rcom homepage www.Rcom.co.kr.

Rcom is designed for user's easy and convenient use.
It can be changed without notice for improvement in performance,
design,treatment, and software, etc.



www.Rcom.co.kr

SELLER

MANUFACTURER

AUTOELEX CO.,LTD.

- Head Office : Deokam 612 Juchon Gimhae
621-843 KOREA
- TEL : 82-55-337-2560 (Direct to sales team)
82-55-337-2561~3 (Office)
- FAX : 82-55-337-2568
- E-MAIL : Rcom@Rcom.co.kr

Rcom is the Best Design with High Quality, Value, and Performance!