

Love of life begins with "Rcom"

World's Best Selling Incubator

# KINGSURO 20

REV. 3.1

## DIGITAL EGG INCUBATOR USER'S MANUAL KINGSURO MAX 20



# Rcom





How to Use Rcom KING SURO MAX 20

<b>1. Introduction</b>	
(1) KING SURO 20 Introduction	4 ~ 8
(2) Safety Precautions	
(3) Identification of Parts and Composition	
(4) Name & Function of Operation Parts	
<b>2. Before use</b>	
(1) What's an Incubation Room?	9 ~ 15
(2) How to Assemble Main Body	
(3) How to Assemble the EGG VAN	
(4) APS Assembly / Speed Control / Tube Replacement/ Storage and Cleaning	
(5) Humidity & Air Maintenance During Incubation / Dew Condensation	
<b>3. Incubation</b>	
(1) Incubator Installation	16 ~ 18
(2) Incubation start / How to Stop Egg Turning / Incubation Termination	
<b>4. Function Settings</b>	
(1) Incubator Initialization / Return to Factory Setting	19 ~ 22
(2) Temperature & Humidity Setting / How to Set Abnormal High & Low Temp. Alarm	
(3) How to change Centigrade & Fahrenheit / Work Automatic Pumping System by Force	
<b>5. Management</b>	
(1) Maintenance after Hatching	22 ~ 24
(2) How to Disassemble and Clean the Incubator	
<b>6. Product Information</b>	
(1) How to Replace the Fuse	25 ~ 29
(2) Frequently Asked Questions (FAQ)	
(3) Troubleshooting	
(4) Specification	

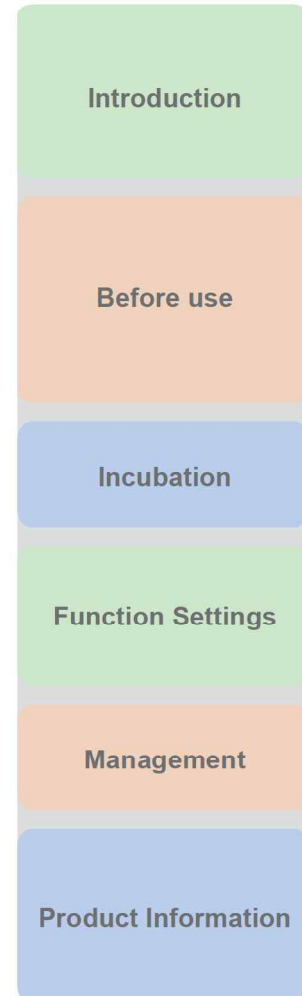

**!** Successful hatching depends on many numbers of factors. Neither Autoelex (Rcom) nor its global distributors and vendors can be held responsible for loss of life or property damage caused by user neglect, alteration, modification or painting, change of use or power failure. To avoid errors, mishaps and danger, carefully check this User Manual before initial use. Also please check the manual regularly to ensure your operation of the machine is correct.

Mark Explanation



Caution : Caution mark against a fault that can cause damage, trouble, or failure of incubation.



Prohibited.



It is necessary to keep.



Do not disassemble.



Remove the power cord from outlet.



Do not touch.



Ground Connection for preventing electric shock.



Tip : References or useful suggestions in using Rcom product



Warning of actions which may be dangerous or cause damage to the incubator.

### Rcom King Suro 20

Thanks for using Rcom King SURO 20 incubator.

SURO is the name of an ancient King in GimHae area who has born from an egg, and he is revived. The Rcom Suro incubator is based on experienced incubation technique and best quality management. The King SURO incubator is designed on easy and simple use as a customer oriented product, however the user's incubation knowledge and proper operation is very important for the best incubation result.

Therefore, be sure to read this user manual carefully before use. Rcom King SURO offers optimum incubation conditions, but users need to observe and manage all incubation conditions such as species of eggs, temperature or humidity for each incubation period, and incubation circumstance. Also, adjustment by users is available.

### Features of King SURO 20

#### [Main Features]

- \* Luxury design with streamlined egg shaped concept
- \* Automatic Temp. setting and control
- \* Automatic Humidity setting and control
- \* Artificial intelligence electronic control device to automatically adjust the cycle of incubator according to the ambient conditions
- \* Automatic egg turning function with Auto Egg Van (Cradle)
- \* Convenient humidifier with Automatic Pumping System (A.P.S)
- \* Clear and transparent large view-window
- \* Minimizing the parasitic bacteria by not using any interior material and using revolutionary hygienic duplicated insulation structure (bottom-egg tray)
- \* Variable air control lever to control air amount inside the incubator
- \* Applying RCOM's optimum air flow technology to avoid the fan's air from directly touching egg
- \* 24 egg capacity in the case of chicken egg size
- \* Enhanced reliability by applying Swiss's Sensirion's 3rd generation temperature & humidity sensor

#### [Easy Features]

- \* Degree C / degree F interchangeable
- \* Alarm and indicator function for abnormal high or low temperature by drastic and unusual outer temperature change
- \* Incubation data memory function and power outage notification function in case of power outage
- \* Closed structure to avoid waterdrops (condensation) on the view window from leaking out of incubator
- \* Rotating heater support which conveniently controls the tension of the heater
- \* Application of Water Nipple to supply water easily for humidification
- \* Automatic humidification function for minimum 2 minutes (Press + button for 10 sec.)
- \* Automatic Humidification Pumping System, and precise Speed Regulator VR to control the amount of pumping
- \* 4 Air Vent Holes for inflow of fresh air from outside to inside by affecting the heat insulation to the minimum
- \* Not required to have a balance weight with the optimized incubator design considering the centroid of incubator's top and bottom when eggs are placed
- \* Different kinds of egg can be placed on egg tray, and Egg divider made of ABS material, which has perfect elasticity
- \* The bottom of the egg tray is made with embossed skid-resistance floor to prevent young birds from deformity in their leg
- \* The Automatic Pumping System (APS) for accurate humidification, as a pump of silicone tube, is structured to make tube changed with easy and durable by installing mini roller on the four areas with friction

**Electrical hazards**

**CAUTION** Be careful the details below when you use.

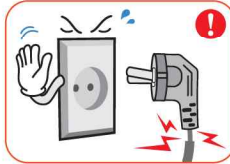

Do not use a damaged power cord or loose outlet.  
▶ Risk of electric shock or fire.



Do not pull the cord when taking out the power cord, and keep wet hands away from connecting plug.  
▶ Risk of electric shock or fire.

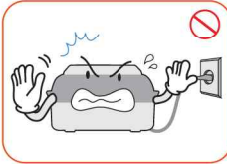

Never pull the plug out of the outlet during the incubation period.  
▶ Incubation will be interrupted.



Do not twist or crush electric cord.  
▶ Risk of electric shock or fire.

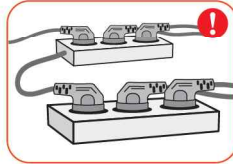

Do not insert multiple connecting plugs in an outlet.  
▶ Risk of fire or electrical overload.

**Setting Cautions**

**CAUTION** Be careful the details below when you use.



Do not install in dusty or dirty environment.  
▶ Risk of damage or fire within the incubator.

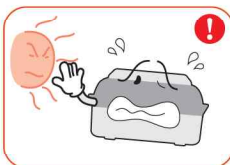

Do not install under the direct sunlight.  
▶ Risk of fire or interference with the incubation process.

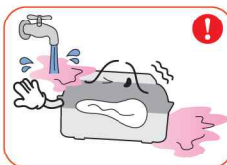

Do not install in moist or humid environment.  
▶ Risk of fire or electric shock.



Do not install in excessively cold or hot conditions, cigarette smoke, etc.  
▶ Risk of interference with the incubation process.

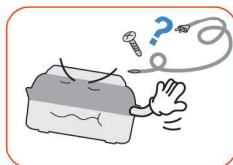

Do not use any other non-standard parts except those provided.  
▶ Risk of damage or hatching failure.



Do not cover the ventilating opening.  
▶ Inner temperature can rise, interrupting incubation.

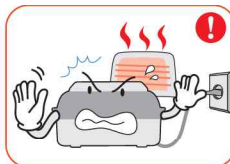

Install away from heat sources.  
▶ Risk of damage to the incubator case and interference with the incubation process.



Ensure that the incubator is installed on a stable surface away from edges.  
▶ Risk of damage to incubator and eggs and user from accidental knocks or drops.



Do not turn the incubator upside down.  
▶ Water will pour out of the incubator, and view window can be dropped or damaged.



Children should be supervised to ensure that they do not play with the appliance.  
▶ Risk of knocking the incubator or accidental interference with the controls.

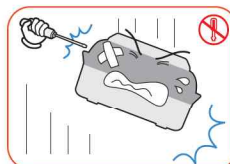

Do not disassemble or modify the incubator in any way.  
▶ Risk if electric shock or fire.

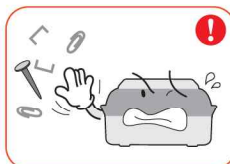

Please ensure that no small objects get into the holes on the incubator.  
▶ Risk of electric shock or fire.

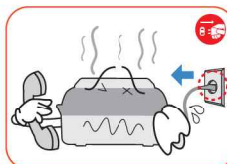

If the incubator sounds strange or emits smoke contact your service center.  
▶ Risk of electric shock or fire.



Clean the incubator thoroughly before storing.

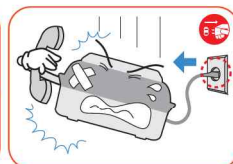

If the incubator requires repair disconnect from the power supply and please contact to your service center.

**Cleaning Cautions**

**CAUTION** Be sure to disconnect the electric cord from the outlet before cleaning.



Do not spray cleanser directly on the incubator surface.



Clean the incubator by a soft cloth with a neutral detergent.



Brush away dust on the plug with a dry cloth.



Do not use chemicals like wax, benzene, alcohol, thinner, aromatic, or lubricant, etc.

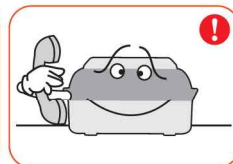

For special cleaning of inner part per year, contact to the service center.  
▶ If you don't clean the inside of incubator for a long time, dust can cause some trouble or a fire.

Identification of Parts

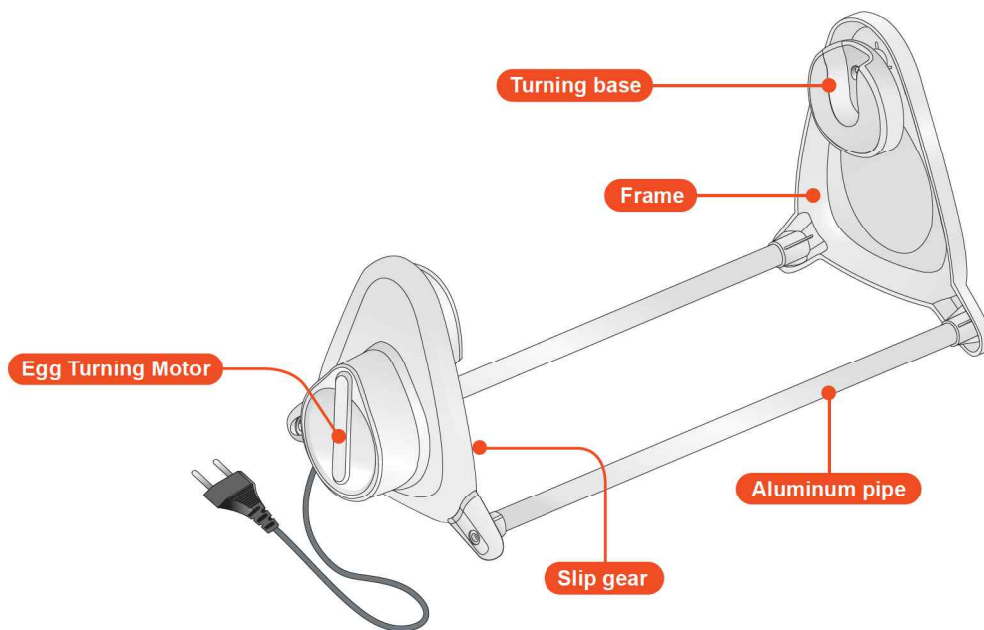
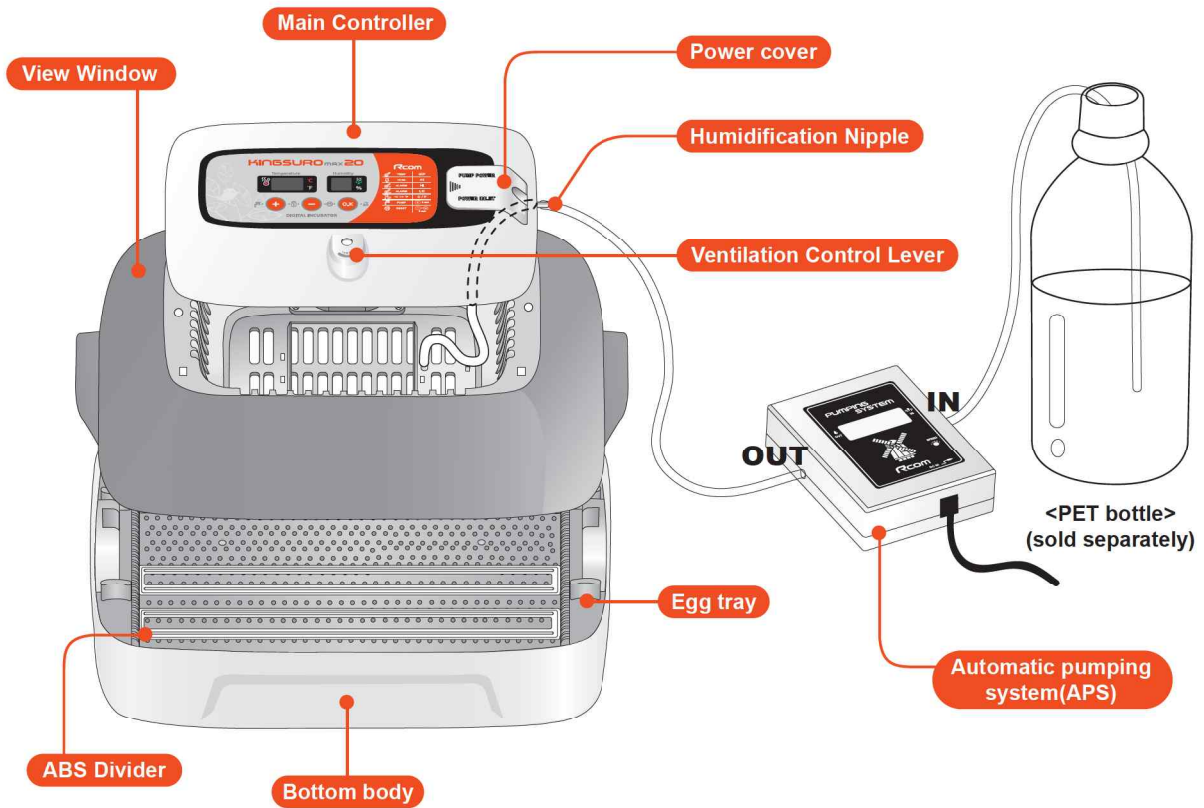

Basic Components

Your Serial no. located on left-side of the main controller. Please be sure not to get dirty or break.  
(ex:RCM0000000)



Rated voltage and product serial No. are marked inside of power cover.  
Be sure to check this before connecting power.

Power Cap



Main Controller

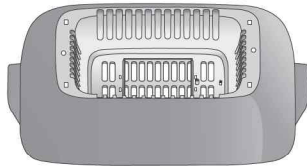

View window

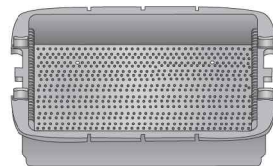

Egg Tray

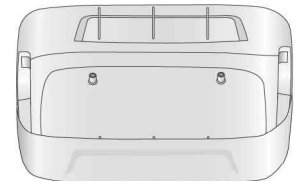

Bottom body



(Silicon Tube)  
12.5cm (diameter : Ø2.6 \* 3.5)

Nipple (1pcs.)

(1pcs.)

Power Cover fixing bolt

(2pcs.)

Main Controller Assembly Bolts

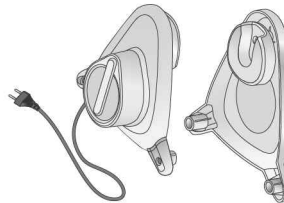

Egg Van (Cradle)



ABS Divider



Power Cord



Manual



Expendables



Hatching Pad

APS Components

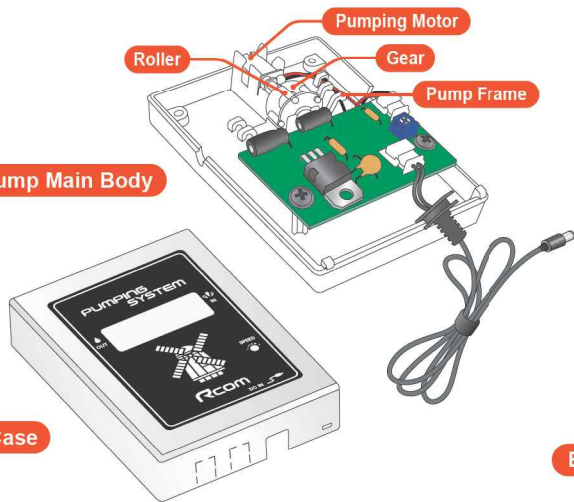

3.5cm (diameter : Ø2.6 \* 3.5)

Silicon Tube and Nipple (2pcs.)



(Humidity Pad Fixing Use)

Humi Pad Clip (2pcs.)



Bolt (2pcs.)

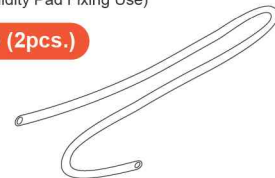

1.5m (diameter : Ø2.6 \* 3.5)

Silicon Tube

Name & Function of Operation Parts

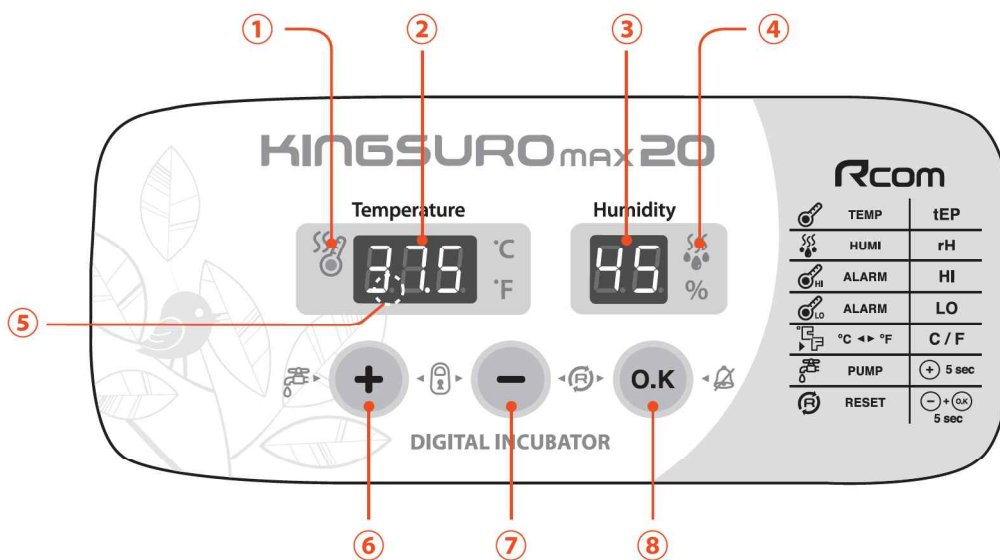

● Names and components of each part

- ① **Heater Operation Lamp**  
: Light on when working
- ② **Temp. Display**  
: Current Temperature Display
- ③ **Humidity Display**  
: Current Humidity Display
- ④ **Pumping System Operation Lamp**  
: Light on when working
- ⑤ **Power Failure Alarm Function (FND light)**  
: Light on when power failure (Cancel Button : OK)
- ⑥ **Up Button**  
: Setting Temp. & Humidity UP
- ⑦ **Down Button**  
: Setting Temp. & Humidity DOWN
- ⑧ **Menu Selecting Button**  
: Setting Value check

**Tip** Kingsuro is available to automatic humidity raise only, if you want to control low humidity level, please adjust "Air Controlling Lever" by manual [refer to page 15]

	Setting Mode: Press two buttons at the same time to go to Setting Mode.
	Select Menu / Quick Movement / Cancellation / Setting value check during incubation
	Value + / APS is forced to operate if press 5sec. / APS is forced to operate for 2min. if press 10sec.
	Value - / Factory Initialization

● Function Key

Function	Temp.	Humidity	Abnormal High Temp. Alarm	Abnormal Low Temp. Alarm	Centigrade / Fahrenheit
Display	tEP	rH	HI	LO	°C / °F
Default Setting	37.5°C	45%	2°C	-3°C	°C



### What's an Incubation Room?

The Incubation Room is a confined space for setting and operating an incubator. Because the incubation room environment has a considerable effect on hatch rate, it's recommended to control the environment for setting up an incubator; there should be little noise and vibration around 22~25°C(71.6~77°F) with small variation in temperature.

Especially, if there are frequent occasions when the temperature drops suddenly at night, compared with daytime, be sure to check from time to time and pay attention so that the incubator is not directly exposed to sunlight during daytime.

**⚠** When the temperature of incubation room is lower than, recommended setting temperature there could be water-droplets in side of incubation room or water leak on the floor. because of dew condensation.

### How to Assemble

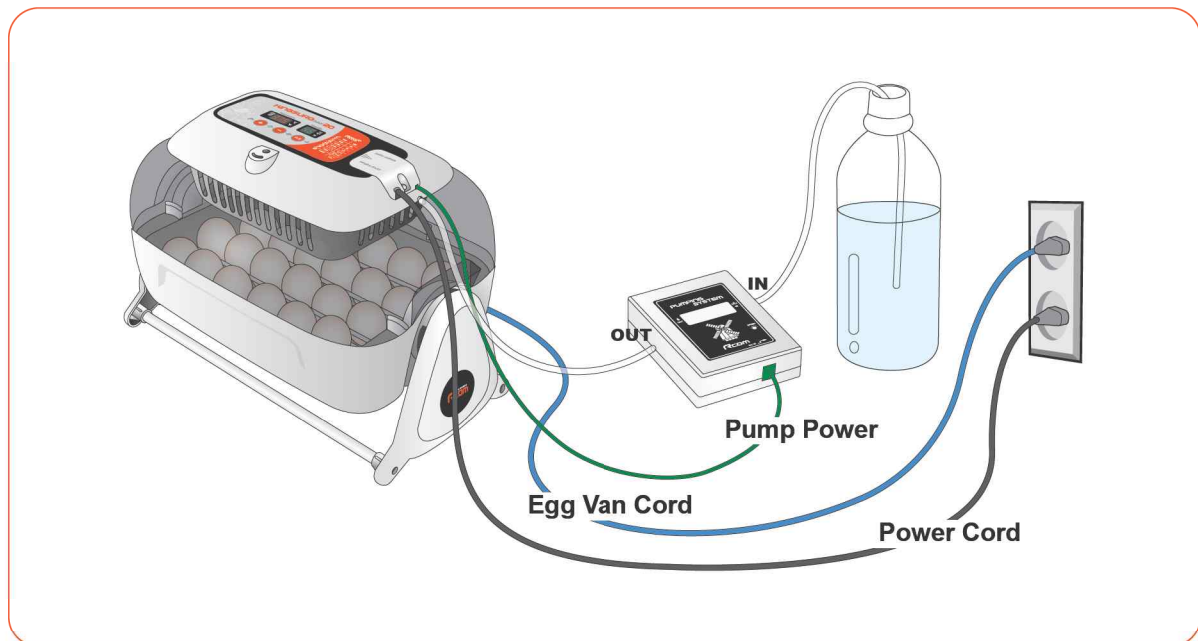

#### [ How to Assemble Main Body ]

- ▶ Please remove all packing from the incubator and parts. Then, check each part is present and undamaged. (Please keep the carton and packing materials for repacking to retain the incubator in good condition when not using.)
- ▶ (EX:RCM0000000) If you register your information with your machine's serial number on our web-site([www.Rcom.co.kr](http://www.Rcom.co.kr)), you can get 2 year warranty service. [Refer to the page 27]



- ▶ Loose two bolts connecting main controller and view window. After that, disassemble main controller from view window by pulling 4 hooks on main controller.

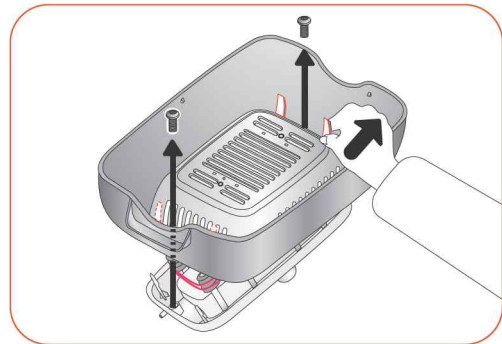

- ▶ Fix silicone tube which is assembled with nipple into the hole.

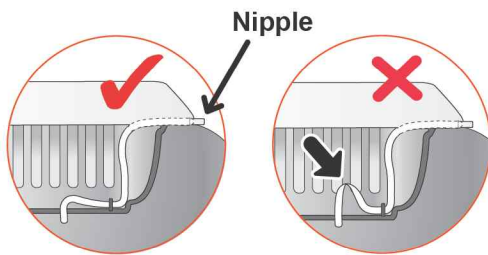

 Be careful to ensure the silicone tube is not folded.

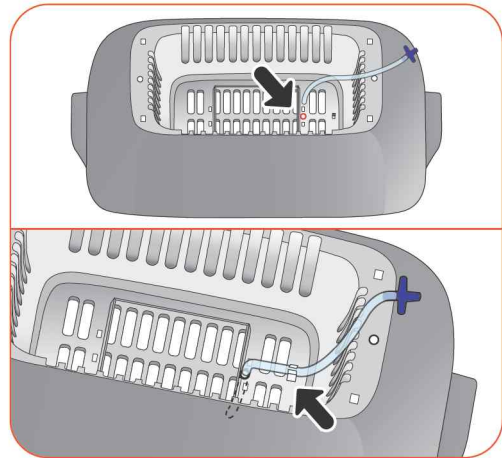

- ▶ Insert the nipple which is connected with view window to the hole of main controller, and assemble view window and main controller with two bolts.

 Do not tighten the bolts too much.

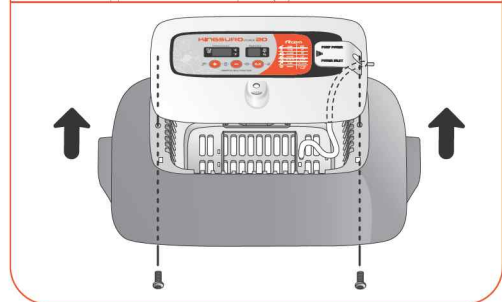
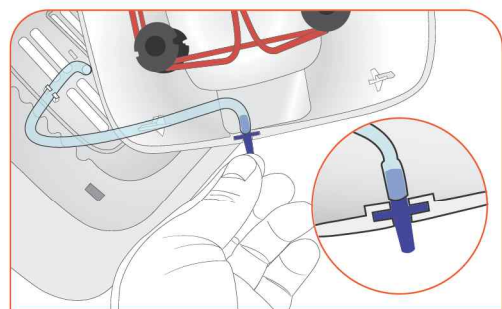

- ▶ Cut Humidity pad to proper size, and then fix on the view window with 2 pins included.

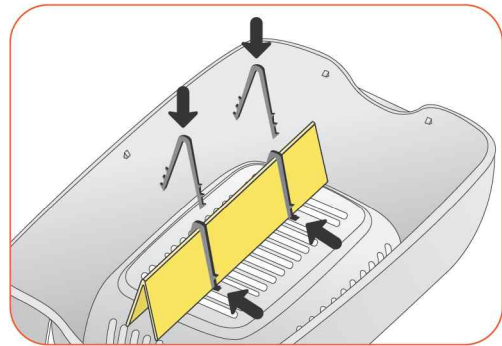
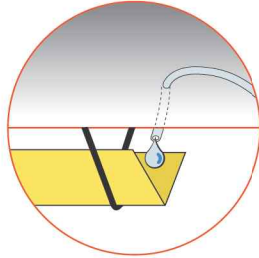
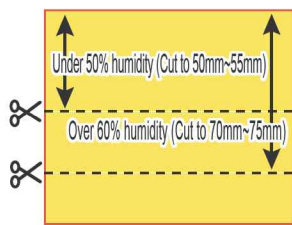

- ⚠ Evaporating ability is different from pad size.

- ※ You can use Humidity pad for about 4 ~6 months, but it can be different depending on water quality. (DISTILLED WATER is recommended to use.)

- ※ Humidity pad can be purchased separately.

- ▶ Assemble bottom body, Tray, and Tray hatching pad.

- ⚠ Ensure hatching pad is placed in egg tray.

- ※ After hatching finished, be sure to wash and dry tray mat completely for next use.

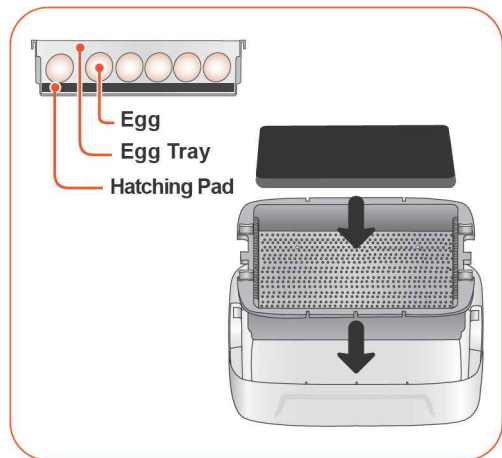

- ▶ Place eggs by adjusting tray divider according to egg size.

- ⚠ Control the space of eggs and divider optimally so the eggs are not interrupted for incubation.

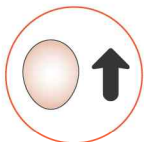

It is recommended to place eggs with sharp end down.

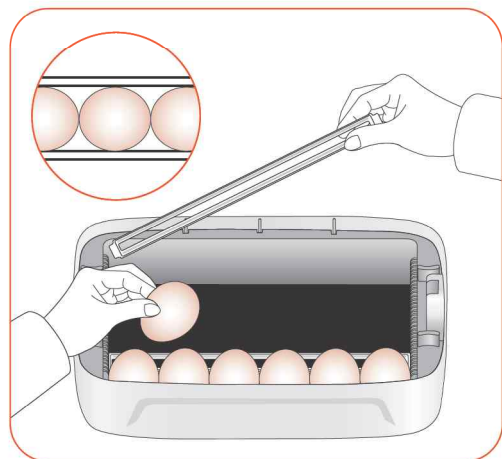

- ▶ Place eggs and cover view window.

 If view window is not closed completely, temp. fails to go up.

 Test the incubator to be sure that the incubator works without any problem before placing eggs in the incubator. Please ensure you remember how to use the machine and maybe re-read instructions.



[ How to Assemble the EGG VAN ]

- ▶ Insert aluminum pipe to the frame exactly. Place the EGG VAN on a flat surface, and tighten the bolts. Incubator can drop in case of wrong assembly.

 Do not turn the incubator manually when the incubator is on the EGG VAN.  
(It can cause egg turning device failure.)

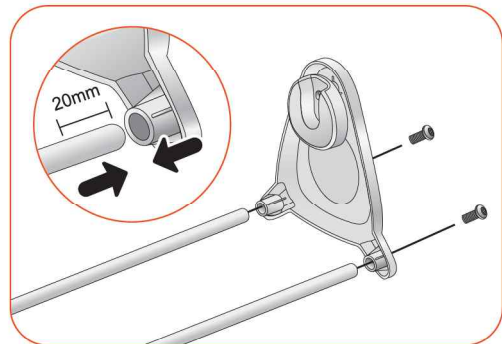

- ▶ Assemble opposite side with same way.

※ EGG VAN turns the incubator and eggs very slowly about 90° per hour. The device can turn irregular intermittently, it is normal.

 Spray lubricating oil such as WD 40 on the gear part or operation part of EGG VAN for helping smooth operation.

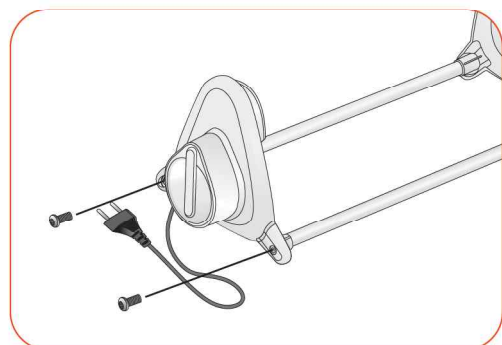

How to Assemble APS (Automatic Pumping System)

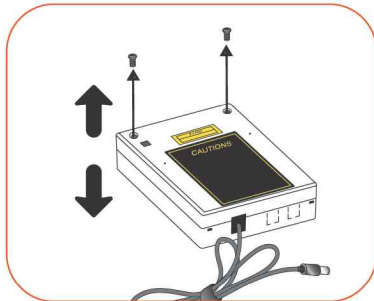

[Pic.1-0]

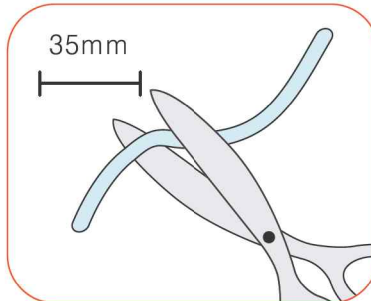

\* Is not required with first use

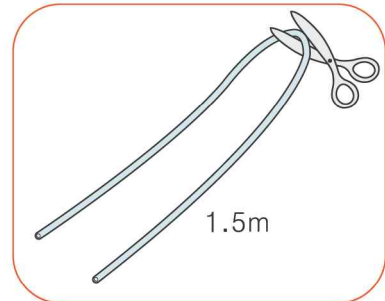

[Pic.1-1]

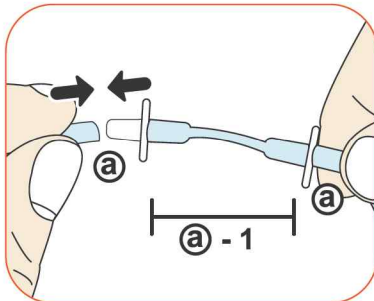

[Pic.1-2]

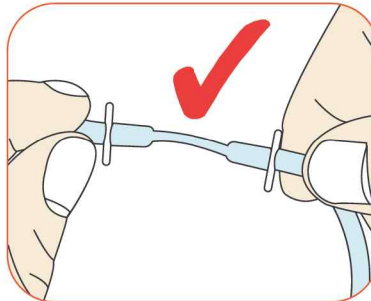

[Pic.1-3]

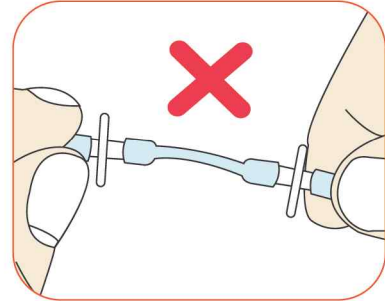

[Pic.1-4]

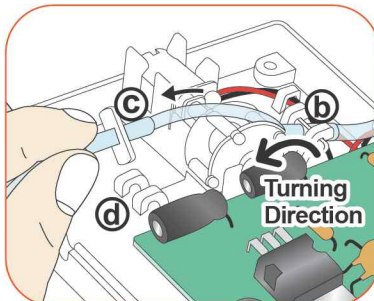

[Pic.1-5]

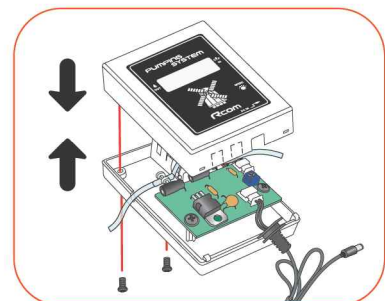
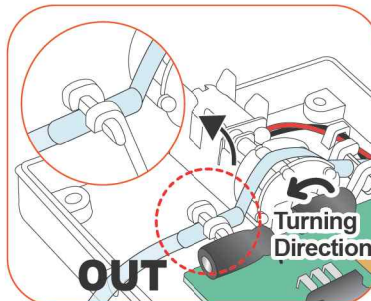

[Pic.1-6]

- ① Cut the silicone tube exactly to 35mm, and insert to nipple as picture 1-2.  
(When you purchase, product is originally assembled as ①-1.)
- ② Cut the silicone tube of 1.5m to half, and insert to assembled nipple ①.
- ③ It is normal if you assembled as pic.1-3. If you do not insert silicon tube to the nipple completely as pic.1-4, pumping will not work well.
- ④ Loose two bolts of APS case as picture 1-0, and insert the assembled silicone tube and nipple as pic.1-3 to the side of pic. 1-5 ②.
- ⑤ Grip the part ③ on Pic.1-5, and pull the silicone tube so that fit to ④.  
(If silicon tube should be assembled tightly.)
- ⑥ Spread IN and OUT of tube so that the silicone tube is not tangled. Insert tube on the groove, and cover the case. Here, be sure to check the silicone tube or wire is not jammed. Refer to the Pic.1-6.

### How to Control Water Flow Speed in APS

- ▶ The amount of water for humidification can be easily controlled with APS.
- ▶ With cross type screw driver, turn "Speed" clockwise to increase water flow and vice versa to decrease.
- ▶ To prevent water over flowing and dropping down in to the chamber, it is recommended to use the APS with lowest water flow speed. (1 drop of water in 3 sec.)

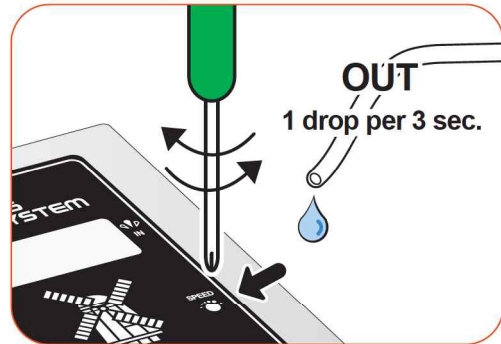

 Humidity will raise up very slowly as artificial intelligence function check and memorize ambient conditions to keep incubator inside with optimum conditions.

### How to Replace the Tube

- ▶ If the silicone tube wear out and it does not pump water effectively, you should replace silicone tube. [Refer to the page 13]

 Be sure to use the silicon tube supplied from Autoelex(Rcom). (Ø2.6 × 3.5)

 If water does not flow out even if pumping motor is working, check if silicon tube is blocked or folded.

※ If it failed in pumping water, check direction of IN and OUT again, and also check if motor is turning with anti-clockwise. Also, length of silicon tube should be 35mm and inserted correctly. [Refer to the page 13]

### Storage and Cleaning

- ▶ Do not wash APS with water but wipe with soft cloth.
- ▶ In case of long time storage, detach the silicon tube from the APS and remove the water from the tube. Keep the tube unkinked. It stops the tube hole from blocking.
- ▶ When assembling again, stretch the tube to open the hole in case the tube is blocked.

### Humidity & Air Maintenance During Incubation

- ▶ When hatching, humidity should be relatively high to prevent the thin membrane from drying out or hardening before hatching.
- ▶ When hatching, it's recommended not to open the lid often. If you open the lid often humidity will be rapidly decreased and it will take a long time to regain the proper humidity.



- ※ If incubator temperature is higher than 37°C (98.6°F) and room temperature is low, it may be difficult to maintain humidity of over RH 70%. There may be some difference of humidity about  $\pm 5\%$  according to the external environment, but no problem with hatching.
- ▶ It's very important to maintain humidity higher 1~2 days before hatching than the early and middle incubation periods. Humidity requirements during incubation are RH 45~55% for waterfowl, RH 40~45% for poultry and RH 35~45% for parrot, in general. (One day before hatching, all kinds of birds need about RH 65% humidity and sometimes need higher than that.) However, in areas of high ambient humidity, lower levels of humidity may be needed during incubation (Rcom Pro20 incubator automatically controls these conditions during the incubation period.)
- ※ Air Controlling Lever : Outer fresh air can be flowed into incubator inside without affecting insulation. When eggs start hatching, open air controlling lever either fully or half-open.

 Check water level every three days during incubation, and refill when needed. You'd better to use tap water than purified water or underground water for avoiding evaporating pad damage. (Evaporating pad is available from Autoalex Co.,Ltd. or Rcom distributors.)

- ※ Evaporating pad is expendables.

### Dew Condensation

- ▶ This is a naturally occurring phenomenon when there is a significant difference in temperature between inside and outside of the incubator during incubation period. If this occurs, water may form in inside bottom of the incubator(bottom part).

 Do not place any goods near the incubator.



#### Incubator Installation

**⚠** Test the incubator to be sure that the incubator works without any problem before placing eggs in the incubator. Please ensure you remember how to use the machine and maybe re-read instructions.

▶ Place Suro incubator on the Egg Van. (egg turning device.)



▶ Open the power cap, and insert the incubator power cord and pump power cord.

**⚠** Be careful to ensure the cords do not get jammed when you tighten screw bolt.

**⚠** If you open power cap, there is a sticker which is showing rated current in the position of pic. ①.

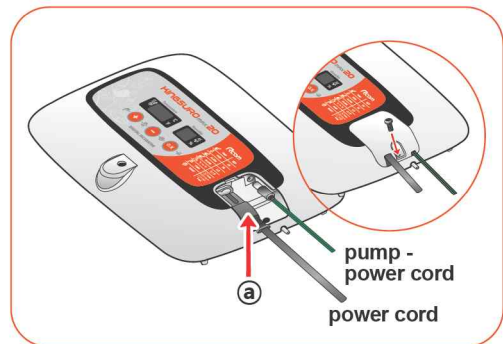

▶ Connect silicon tube end of APS (Automatic Pumping System) into the nipple of incubator, and the other end into PET bottle.

▶ Be sure to check rated current Pic. ① before connecting power cord to outlet.

▶ Press **+** button for about 10 sec. for pump operation, and it automatically stop after 2min. If you want to stop pump operation, press any key.

**⚠** If you do not insert silicon tube exactly, it will not work properly. [Refer to the page 13. How to replace silicon tube.]

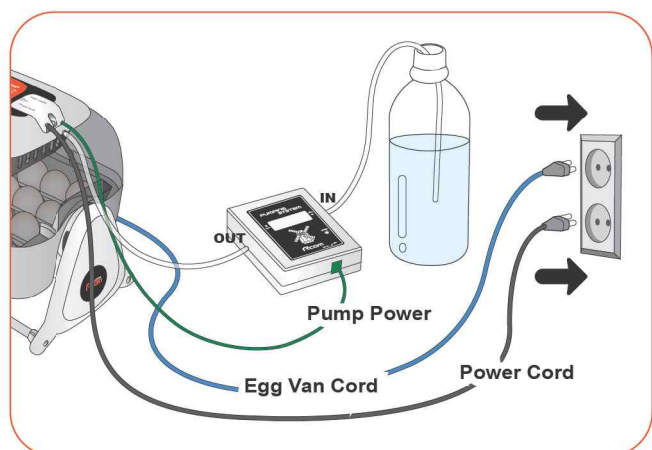



**How to Start Incubation**

- ▶ If you connect power cord, incubator starts incubation with factory set conditions. [Factory setting : Temperature 37.5°C (99.5°F), Humidity RH 45%]
- ※ Start incubation with required temperature & humidity for your species of birds.
- ▶ With incubation start, be sure to place the incubator on the egg van for egg turning. [90 degree per an hour.]

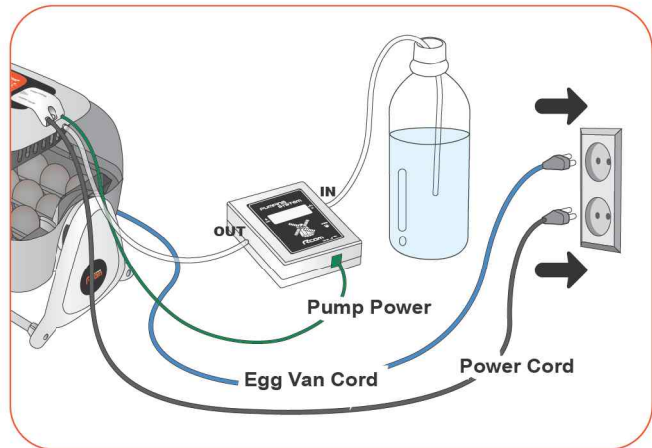

**Tip** There can be some odor the first time you use incubator, which is normal.

- ▶ The first time you connect power, FND light will blink and pump will work for about 2sec. Then, incubator version will be indicated on FND for about 1 sec.
- ▶ After version indication, buzzer sounds for about 15sec. At the same time, present temp. & humidity displayed and power failure alarm indication (a) is blinking.
- ▶ Press (O.K) button to remove buzzer and alarm indication. (Buzzer will be removed automatically after 15sec.)

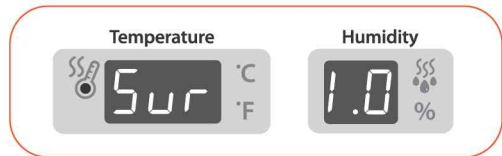

※ Notice of Power Failure : If power is turned off and then on again because of power failure or by mistake, first dot will blink.

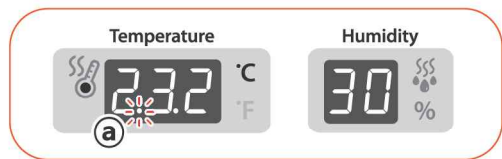

**Tip** Quick Start : If you just connect power, it automatically starts incubation with factory setting. [Factory setting : Temperature 37.5°C (99.5°F), Humidity RH 45%]

▶ Incubator display current temperature and humidity, and it goes to setting conditions within an hour.

※ The artificial intelligence system memorizes and classifies ambient conditions for keeping optimum temperature, and temperature can move up slowly at the first stage.

### Turning stop During Incubation

- ▶ Before 3 days of hatching, disassemble the incubator from EGG VAN, and place on a flat surface to stopping egg turning. After that, remove dividers.

**⚠** Here, be sure to remove Egg Van power cord only. Be careful not to take power cord out of incubator.

- ▶ When incubating various species of eggs at the same time, you can move the eggs three days of before hatching to other brooder for easy and clean management. (You can operate two incubators, and various incubators or brooders are available from Rcom website .)



**Tip** In case of altricial birds such as parrots or wild birds, turn the eggs once or twice additionally by hand.

### Incubation Termination

- ▶ There is no specified ON or OFF button on the incubator. Just turn off the power cord after hatching.
- ▶ It is not necessary to do Incubator Initialization with KING SURO 20 incubator after hatching. Just connect power again when you want to start incubation.

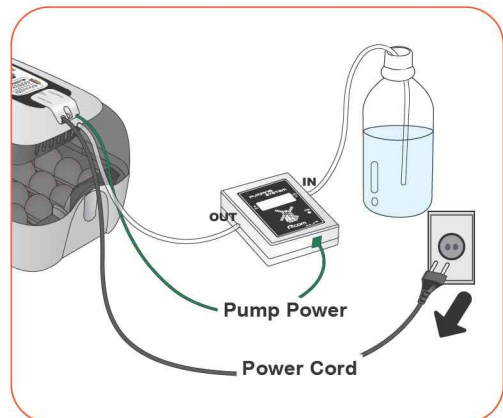

### Incubator Initialization

- ▶ This function can be used when user input wrong setting, or incubation termination.
- ▶ Press **[-]** and **[O.K]** button at the same time for about 5sec. then display will show "rSt" and incubator returns to default setting.



**Tip** Calibrated setting value will not be initialized with this function.  
[If you need to initialize calibrated setting, refer to FACTORY SETTING next page.]

### Return to Factory Setting

- ▶ This function is for return incubator to factory setting.
- ▶ Unplug power cord. Replug during  button is pressed. Then, "rSt AL" will be indicated in display, and incubator returns to factory setting. [Default setting]



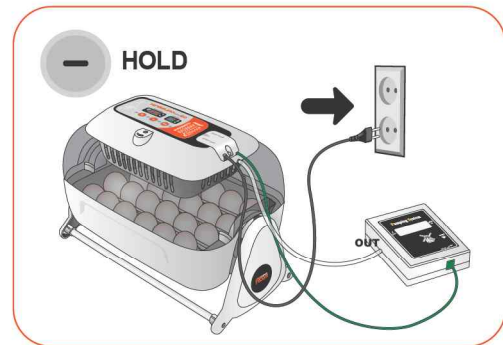

 Calibrated temperature and humidity will also return to factory setting.

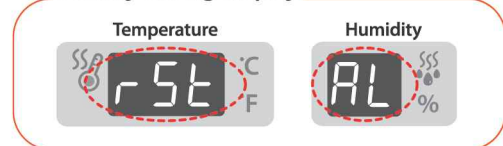

#### Factory Setting Display



### Temperature Setting

- ▶ Press  and  buttons at the same time then "tEP" will be indicated for about 0.5sec. and then temp display will blink.
- ▶ Then, you can adjust temperature with  and  buttons. [Default setting: 37.5°C (99.5°F)]
- ▶ After setting required temperature, press  button once then setting will be stored. Next, "rH" will be indicated in humidity display for about 0.5 sec. and then humidity display will blink.

※ Just press  button if you do not need to change setting.

#### Step 1

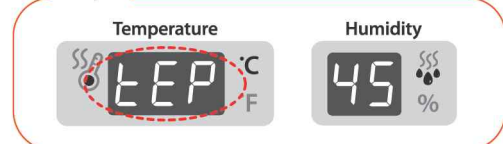

#### Step 2



### Humidity Setting

▶ When humidity display is blinking, adjust humidity setting with **+** or **-** button. [Default setting : RH 45%]

▶ After setting required humidity, press **OK** button once then setting will be stored. Next, "HI" will be indicated for about 0.5sec. and then maximum temperature limit will blink.

※ Just press **OK** button if you do not need to change setting.

#### Tip Function Key

Function	Temp.	Humidity	Abnormal High Temp. Alarm	Abnormal Low Temp. Alarm	Centigrade / Fahrenheit
Display	tEP →	rH →	HI →	LO →	°C / °F
Default Setting	37.5°C	45%	2°C	-3°C	°C

Tip Kingsuro is available to automatic humidity raise only, if you want to control low humidity level, please adjust "Air Controlling Lever" by manual [refer to page 15]

Tip The temperature and humidity level is optimized according to the international standard at the time of ship ping. It could be recalibrated by the user if the user wishes to do so, but this is not recommended. When in need of adjustment, please refer to our homepage ([www.Rcom.co.kr](http://www.Rcom.co.kr) → Information → User Manual Category) or contact the place of purchase. Commercially available thermometer and hygrometers may have drastic measurement deviations, so it is recommended to use thermometer and hygrometer designated for this purpose. [Designated Thermometer and hygrometer – Refer to Rcom Homepage]

#### Step 3



#### Step 4



### How to Set Abnormal High Temperature Alarm

Tip Abnormal High temperature: This function gives notice when incubator temperature is higher than setting temperature because of abnormal ambient temperature increase. When room temperature is higher than incubator temperature, this function works with buzzer. Here, "HI" and temp. gap are displayed alternatively. Press OK button to remove buzzer.

▶ Adjust abnormal high temperature value with **+** or **-** button. [Default setting : 2°C (2°F)]

▶ After setting required value, press **OK** button to save. Then, it will go to the next stage, abnormal low temp. setting with display "LO" for about 0.5 sec.

#### Step 5

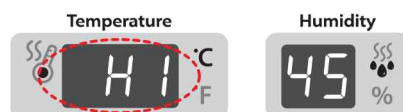

#### Step 6

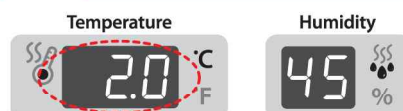

※ It shows that the set temperature value is approximately 3°C (3°F) higher than the Maru incubator's incubation chamber(the Cabinet).

**How to Set Abnormal Low Temperature Alarm**

- ▶ This function gives notice when incubator temperature is lower than setting temperature because of abnormal ambient temperature decrease.
- ▶ Adjust abnormal low temp. setting with **+** or **-** button. [Default Value: -3°C (-3°F)]
- ▶ After setting required value, press **OK** button to save. Then, it will go to the next stage, °C & °F change.

**Tip** Abnormal Low Temperature: "LO" will indicated on LCD. (The others, same with abnormal high temp. alarm function.)

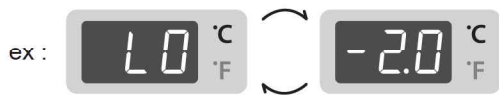

※ It shows that the set temperature is 2°C (2°F) lower than the actual cabinet temperature of the machine.

Step 7

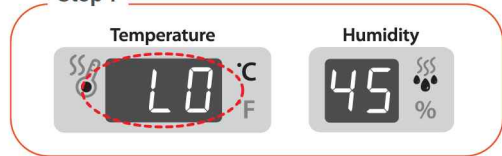

Step 8

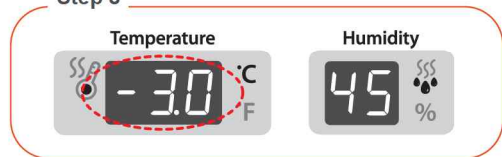

**How to change Centigrade & Fahrenheit**

- ▶ Select °C or °F with **+** or **-** button.
- ▶ After selecting °C or °F, press **OK** button to save. [Default setting : °C]

**Tip** °C = 5/9 (°F - 32)

Step 9

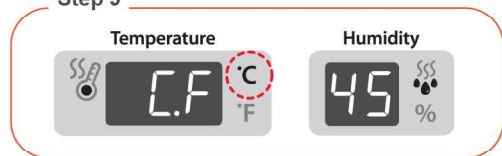

Step 10

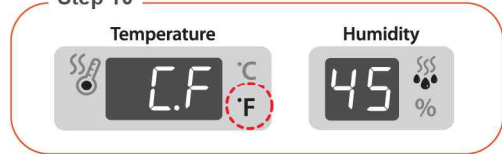

### How to Work Automatic Pumping System(APS) by Force

- ▶ Press **+** button for about 5sec. during incubation process. Then, PUMP will operate by force with LED light on.
- ▶ Press **+** button for about 10sec. then pump motor works for 2min. by force. It still works for 2min. even if you remove your finger from the button.

 If you press **+** button for about 10sec. pump will operate for about 2min. Press any key to remove.

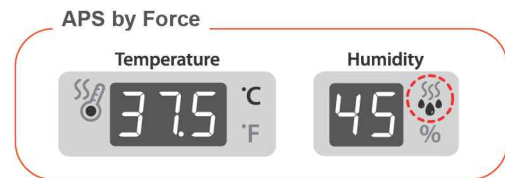

### Maintenance after Hatching

- ▶ Newborn birds are vulnerable to cold so it is essential to have a separate development room (brooding device) In case of developing (brooding) inside the incubator, the incubator can easily become contaminated with various bacteria which can become a major cause of reduction of hatching rate and various feather, dust, bark, manure and other pollutants can become the cause of incubator failure. In case of failure due to inappropriate usage can cause repair costs to occur even if it is within the free A/S period so purchasing of a separate development(brooding) is recommended. Instructions to build a simple development (brooding) room can be found on our homepage. ([www.Rcom.co.kr](http://www.Rcom.co.kr) → Rcom Study → Making a birdcage)

 Do not developing chicks inside the incubator. It becomes the source of malfunction of the device and repair charges will rise even if it is within the free A/S period.

 Generating Room : Space for hatching (breaking of the egg) and used 1~3 days before hatching (Rcom maru H&B)

Development (Brooding) Room : A device designed for newly hatched chicks to adjust to the environment by maintaining proper temperature and humidity for certain amount of days. (Rcom maru H&B / Rcom bird brooder & ICU)

- ▶ As there is some difference in chick feed for each kind of bird, so it's desirable to obtain useful information about the chicks before hatching.



### How to Disassemble and Clean the Incubator

**!** Be sure to take off power cord before cleaning the incubator.

- ▶ After incubation terminated, never leave the incubator covered with view window. Moisture inside of the incubator vaporizes and it can stick to electric parts causing operation failure. Be sure to dry the incubator perfectly.

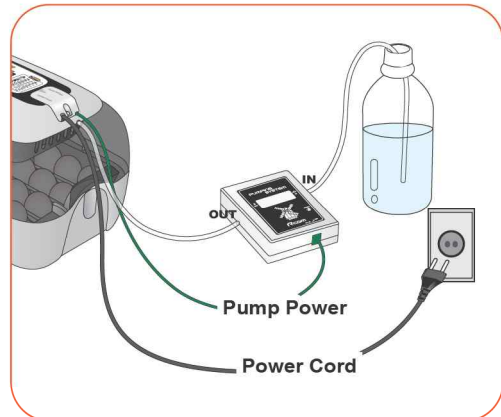

- ▶ Remove main controller from view window. [Refer to the page 10]

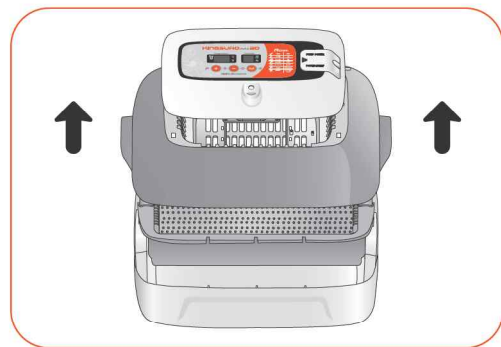
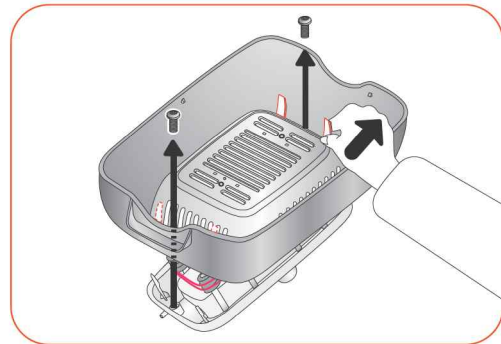

- ▶ Wipe the main controller smoothly with soft brush. Be careful not to give impact to sensor part or heating part.
- ▶ Temp. & Humidity sensor is assembled with connector for easy replacement in case of trouble.

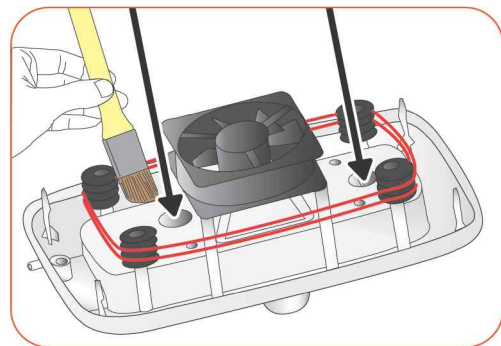

- ▶ Wash the window, tray, hatching pad and main body with warm water.

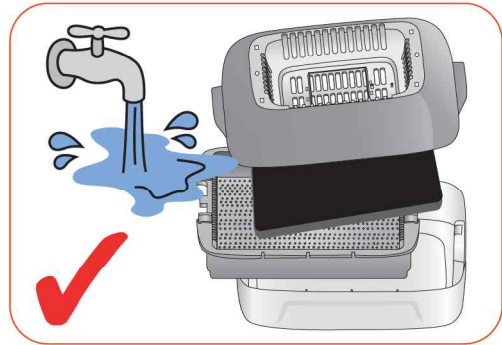

- ▶ Do not wash EGG VAN and Automatic Pumping- System (APS) with water, just wipe with a soft cloth.

- ⚠ Do not use benzene or thinner when wipe the unit. It can cause transformation or decoloration.



- ▶ Wipe the exterior with a soft cloth, and completely dry before storing.





### How to Replace the Fuse

- ▶ If power does not turn on even if you connect the plug, check fuse.

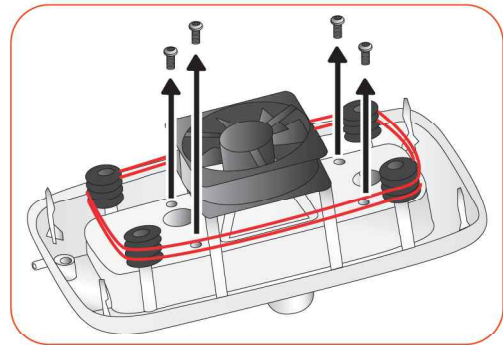

- ▶ Open the cover as Fig. then you can see fuse equipped PCB. Remove damaged fuse with screwdriver.

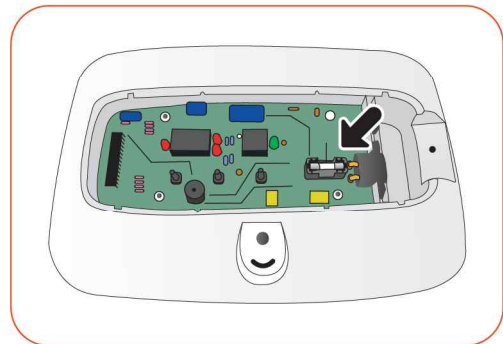

- ▶ Replace with new fuse.  
( 250V 2.0A Ø5\*20mm )

- ▶ Reassemble with the opposite order of disassemble.

- ※ If the cover is not completely closed, moisture preventing ring will not attached correctly and moisture can be flow in to the PCB part.

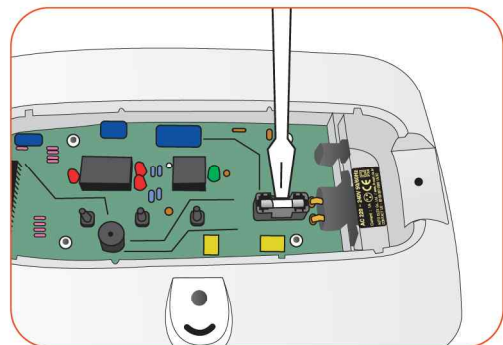

## Frequently Asked Questions (FAQ)

All our Rcom digital products of Autoelex Co., Ltd. are made by precision systems under strict quality control. But occasionally some defective products are found on the way of their distribution. If any problem occurs, then please contact Autoelex service center or distributors in your country. We will do our best to solve the problems, if any, for you. This product is designed in modular mode, so for its repair, if any, a qualified person can replace the part concerned with ease.

\* Complaint Department : 82-55-337-2560

\* E-mail Receipt : Rcom@Rcom.co.kr

Troubles	Expected Causes (Possibility)	Countermeasures
<b>In case hatching rate is low</b>	<ul style="list-style-type: none"> <li>▶ When the egg is an unfertilized egg.</li> <li>▶ Getting infected by germs.</li> <li>▶ Wrong incubation setting.</li> <li>▶ Health condition of mother bird.</li> <li>▶ Improper egg turning.</li> </ul>	<ul style="list-style-type: none"> <li>▶ Inspect the egg to check possibility of egg surviving.</li> <li>▶ Disinfect the incubator.</li> <li>▶ Check all settings of incubator. Especially, check them focusing on the temperature.</li> <li>▶ Review care of health of mother bird.</li> <li>▶ Check if egg turning is normal.</li> </ul>
<b>When a chick hatches out earlier than expected or a deformed chick hatches out</b>	<ul style="list-style-type: none"> <li>▶ Setting temperature high.</li> <li>▶ Egg turning was not operating normally.</li> </ul>	<ul style="list-style-type: none"> <li>▶ Lower temp. setting of the incubator about 0.5°C (1°F) ex) 37.5°C (99.5°F) → 37.0°C (98.6°F)</li> <li>▶ Check if egg turning function is OFF.</li> </ul>
<b>When a chick hatches out later than expected</b>	<ul style="list-style-type: none"> <li>▶ Setting temperature low.</li> </ul>	<ul style="list-style-type: none"> <li>▶ Raise temp. setting of the incubator about 0.5°C (1°F) ex) 37.0°C (98.6°F) → 37.5°C (99.5°F)</li> </ul>
<b>When hatching dates are so different from each egg (When all chicks don't hatch out at the same time but over a long period)</b>	<ul style="list-style-type: none"> <li>▶ Eggs stored for different lengths of time.</li> <li>▶ Different incubation temperatures.</li> </ul>	<ul style="list-style-type: none"> <li>▶ Minimize the time to store egg properly.</li> <li>▶ Check Temperature difference in the incubator. (sunlight, temp of incubation room, etc.)</li> </ul>
<b>When intending to hatching various eggs at the same time</b>	<ul style="list-style-type: none"> <li>▶ Incubation days are different, so hatching rate falls down.</li> <li>▶ Eggs might be contaminated by chicks that hatched first.</li> </ul>	<ul style="list-style-type: none"> <li>▶ Mark hatching date on eggs and move them to other incubator(brooder) just on the marked date.</li> <li>▶ In case of putting in many eggs at the same time, it's convenient to prepare a spare incubator available as a Hatcher&amp;Brooder.</li> </ul>

### Troubleshooting

For more detailed self-diagnosis, see Rcom homepage "SELF DIAGNOSIS" category.

Circumstance	Items to be confirmed	Solutions
<b>No signs of power to the incubator.</b>	<ul style="list-style-type: none"> <li>▶ Check electric cord is properly connected.</li> <li>▶ Check if there is a power outage.</li> <li>▶ Check whether the plug is damaged.</li> <li>▶ Check the fuse is not blown. [Refer to the page 25]</li> </ul>	<ul style="list-style-type: none"> <li>▶ Connect the cord again.</li> <li>▶ Check the main socket with any other electric appliances.</li> <li>▶ Try to insert to another outlet.</li> <li>▶ Replace the spare fuse in the fuse box. (250V 2.0A)</li> </ul>
<b>When temperature is too high / When temperature is too low</b>	<ul style="list-style-type: none"> <li>▶ Check your setting temperature.</li> <li>▶ Check the air circulation FAN is working.</li> <li>▶ Initialize the incubator. [Refer to the page 18]</li> </ul>	<ul style="list-style-type: none"> <li>▶ Set the temperature as required.</li> <li>▶ Take the power plug out of the outlet, and disassemble the main body for cleaning around the air circulation fan with brush.</li> </ul>
<b>When humidity is too high / When humidity is too low</b>	<ul style="list-style-type: none"> <li>▶ Check water is enough.</li> <li>▶ Check setting humidity.</li> <li>▶ Initialize the incubator. [Refer to the page 18]</li> </ul> <p>&lt;When Low&gt;</p> <ul style="list-style-type: none"> <li>▶ Check if evaporating pad is fit well.</li> <li>▶ Check if view window is closed completely.</li> </ul> <p>&lt;When High&gt;</p> <ul style="list-style-type: none"> <li>▶ Check ambient conditions.</li> <li>▶ Check if there is water in bottom body.</li> </ul>	<ul style="list-style-type: none"> <li>▶ Supply water.</li> <li>▶ Set required humidity.</li> </ul> <p>&lt;When Low&gt;</p> <ul style="list-style-type: none"> <li>▶ If evaporating pad does not fit well, humidification device will not work well.</li> <li>▶ Close view window exactly.</li> </ul> <p>&lt;When High&gt;</p> <ul style="list-style-type: none"> <li>▶ Adjust the conditions of room temperature [Refer to the page 9]</li> <li>▶ Remover water inside of bottom body.</li> </ul>
<b>The machine makes some noise.</b> - A little noisy occurs from the inside of circulation fan.	<ul style="list-style-type: none"> <li>▶ Check whether you put anything on the incubator.</li> <li>▶ Check if there is any vibration, or check the incubator set on a table.</li> <li>▶ Check if there is any hatching debris such as feather or eggs-shell in the incubator FAN.</li> </ul>	<ul style="list-style-type: none"> <li>▶ Ensure the incubator is not touching any other items and nothing is on top of the unit.</li> <li>▶ Move the incubator to a flat and even surface.</li> <li>▶ Unplug the power supply and disassemble the main body for cleaning the egg turning tray and gear.</li> </ul>
<b>Dew forms in the incubator.</b> - Dew condensation is normal with high humidity incubation.	<ul style="list-style-type: none"> <li>▶ Check if incubation room temperature is too low.</li> </ul>	<ul style="list-style-type: none"> <li>▶ Check conditions of incubation room, and adjust as required.</li> </ul>
<b>When pumping is slow</b>	<ul style="list-style-type: none"> <li>▶ Check Silicon Tube</li> </ul>	<ul style="list-style-type: none"> <li>▶ Adjust APS speed hole with screw driver.</li> </ul>



Test the incubator to be sure that the incubator works without any problem before placing eggs in the incubator. Please ensure you remember how to use the machine and maybe re-read instructions.

## Specification

1-1 Name : Rcom Kingsuro MAX 20

1-2 Model : MX-SURO

Power	AC 100[V]~120[V], 50/60[Hz] / AC 220[V]~240[V], 50/60[Hz]
Power Consumption	Average 25[W] Max. 48[W]
Egg Van Power Consumption	Average 3[W]
Temp. limits	20 ~ 42[°C] / 68 ~ 107.6[°F]
Humidity Limits	20[%] ~ 70[%] (It can be changed according to the conditions)
Capacity	Chick : 24[EA]      Duck : 20[EA]      Goose : 9 ~ 12[EA] Pheasant : 40[EA]      Quail : 60[EA]      Amazone / Macaw : 36[EA]
Weight	1.9[Kg] / 2.5[Kg] (Including EGG VAN)
Size	(W)370×(L)231×(H)209[mm] / (W)432×(L)231×(H)262[mm] (Including EGG VAN)
Fuse Standard	250[V] 2.0[A] (Ø5*20[mm])



You will be asking for service charge if you are in below cases.

1. Broken or Problem caused by 'No cleaning' or 'Improper handling'
2. Broken or problem caused by 'Not using distilled water'
3. Broken or problem caused by 'Trying Bird hatching in incubator'  
(Please don't try bird hatching in incubator. Please use Hatcher during bird hatching.)
4. Broken or problem caused by 'Wrong controlling(Using)'
5. Broken or Problem caused by using the machine out of User's Manual.
6. Broken or problem caused by 'Customer's mistake or fault'

※ Register your product Serial No. on our website for free 2 years gurantee.

※ Refer to website for how to register. (Free 1 years gurantee in case not registerd.)

※ Product Registration Procedures

If you are a new member of Rcom, you need to log in our website at [www.Rcom.co.kr](http://www.Rcom.co.kr)

1. Click "SIGN UP" on top of the right corner.
2. Fill out the information on the blanks.

If you already registered your information on the Rcom website, please log in to [www.Rcom.co.kr](http://www.Rcom.co.kr).

1. Click "Login" on top of the right corner.
2. Select "Customer" and click "Register Products".
3. Fill out the information on the blanks.

You will need below information to register on our website.

1. Your name
2. Your (home/company) address & Email address, country
3. Your product(model) name & Serial number
4. Date of purchase & Name of purchased shop you bought from

**Rcom Incubator Series**

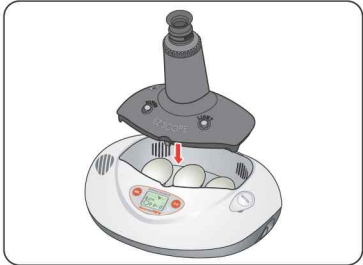

**Rcom PRO MINI (PX-03)**



**Rcom KINGSURO MAX 20 (MX-SURO)**

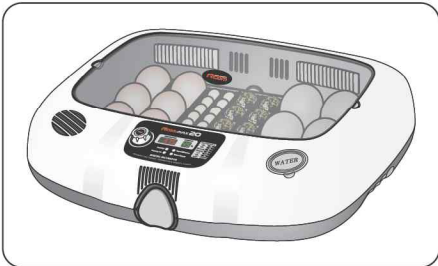

**Rcom MAX 20 (MX-20D)**



**Rcom Bird Brooder&ICU (MX-BS500)**



**Rcom PRO 20 (PX-20D)**



**Rcom MARU DELUXE H&B (MX-380HBD)**

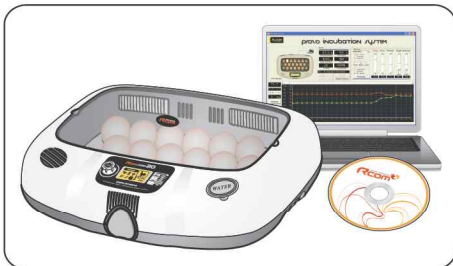

**Rcom USB 20 (UX-20D)**

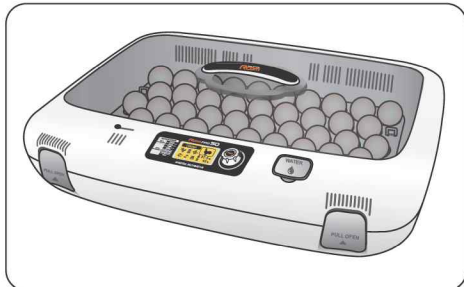

**Rcom PRO 50 (PX-50D)**



**Rcom DIGILOG (PX-V1)**



**Rcom DIGILOG2 (PX-V2)**

## Rcom KING SURO 20 PART LIST

Image	Part No	Names of goods	Image	Part No	Names of goods
	K20-H504-10	K20 Body		K20-A531L-10 K20-A531H-10	K20 Sychro 110Motor K20 Sychro 220Motor
	K20-H503-10	K20 Window		K20-H533-10	EGG VAN AI-Pipe
	K20-H501-10	K20 Bottom		K20-A508(EU)-10	EGG VAN ASM (EU)
	K20-H502-10	K20 Tray		K20-H505-10	K20 CRANK Bar
	K20-H523-10	ABS Divide		K20-H512-10	Heat Support -A
	K20-H511-10	K20 Air Vent Knob		K20-A541L-10 K20-A541H-10	K20 Silicon 110HEATER ASM K20 Silicon 220HEATER ASM
	K20-H510-10	K20 Op-Panel		K20-H516-10	K20 HUMI Pad CLIP
	K20-A524M L-10 K20-A524M H-10	K20 MAX MAIN PCB 110ASM K20 MAX MAIN PCB 220ASM		K20-H521-10	APS COVER
	RCM-A310-10	TH V2 Sensor ASM		K20-H5211-10 (K20-A5211-10)	APS Bottom (APS CASE ASM)
	K20-H506-10	K20 Power Cap		K20-AH518-10	APS MOTOR ASM
	K20-H509-10	K20 Turning Base-R		RCM-600-10	SURO Nipple
	K20-H5091-10	K20 Turning Base-L		K20-H538-10	Silicon Tube (SURO)
	K20-H5081XX	EGG VAN FRAME-L (AU,UK,US,JP,EU,KR)		K20-AH521-10	APS ASM
	K20-H508-10	EGG VAN FRAME-R		K20-H534-10	K20 Humidity Pad
	K20-H507-10	K20 Motor Cover		K20-H535-10	K20 Hatching Pad
	K20-A513-10	K20 Slip Gear ASM		K20-H528-10	K20 BLDC FAN 80
				H20-304(EU)-10	Power Cord(8)



Rcom is designed for user's easy and convenient use.  
It can be changed without notice for improvement in performance,  
design,treatment, and software, etc.



[www.Rcom.co.kr](http://www.Rcom.co.kr)

## SELLER

## MANUFACTURER

### **AUTOELEX CO.,LTD.**

- OFFICE : [F1] Deogam 612 Juchon Gimhae Gyeongnam 621-843 Korea  
[F2] 3, Yanggeun-ro 287beon-gil, Yangpyeong-eup,  
Yangpyeong-gun, Gyeonggi-do, Korea
- TEL : 82-55-337-2560 (Direct to sales team) /  
82-55-337-2561~3 (Office)
- FAX : 82-55-337-2568
- E-MAIL : Rcom@Rcom.co.kr

Rcom is the Best Design with High Quality, Value, and Performance!